



Nortel Communication Server 1000

# **Nortel WLAN Handset 6120 and WLAN Handset 6140 User Guide**





# Contents

Revision history .....	9
------------------------	---

## **Regulatory and safety information** **11**

---

European Union Directives Conformance Statement.....	11
FCC Rules – Part 15.....	11
Industry Canada (IC) Notice .....	11
Charger information .....	12
Operational warnings .....	13
Electromagnetic interference and compatibility.....	14
International certifications.....	16
Specific Absorption Rate (SAR) information .....	17

## **Your WLAN Handset 6120 and 6140** **21**

---

Handset controls and descriptions .....	22
Status indicators .....	24
Modes of operation .....	25
Menu navigation .....	26
Shortcut Keys .....	26
Handset Displays.....	26
Feature Activation displays.....	27
Soft key labels.....	28

## **Cleaning your handset** **29**

---

## **Care of your handset** **30**

---

## **Basic handset operation** **31**

---

Powering on and off the WLAN Handset 6120 and 6140 .....	31
Locking the keypad.....	31
Unlocking the keypad .....	31
Making an internal call .....	31
Making an external call .....	31
Selecting a line.....	32
Entering a number.....	32
Redialing a number .....	32
Answering a call .....	32

Answering a call on a second line.....	33
Muting the microphone .....	33
Placing a call on hold.....	34
Resuming a held call .....	34
Hanging up.....	34
Adjusting the speaker volume .....	34
Changing the ring volume .....	34
Silencing the ringing .....	35
Opening the speed-dial list.....	35
Activating the speakerphone.....	35
Answering using the headset .....	35
Adjusting the headset volume .....	35
Changing the user profile.....	35
Opening the Personal Directory .....	36
Displaying additional features.....	36
Turning on the backlight.....	36

---

## **Advanced features** **37**

---

Facility-specific features.....	37
Speakerphone .....	37
Redial .....	37
Personal Directory.....	37
Real-Time Location System.....	37
Speed-dial call .....	38
The Config Menu .....	39
User-profiles.....	41
Default profile settings .....	42
Data entry and editing .....	42
Alphanumeric Entries .....	43
Push-to-talk .....	43

---

## **Security** **46**

---

---

## **The headset** **47**

---

---

## **Handset display** **49**

---

User Option menu .....	49
Locking the Keypad.....	50
Selecting a Language.....	50

Selecting Ring Options .....	51
Selecting Phone Options .....	56
Viewing system information .....	61
Entering Extension number .....	63
Setting up Push-to-talk.....	63

## **Call features** **67**

---

### **Making calls** **69**

---

Use Autodial .....	69
Activate Ring Again .....	70
Redial last number called .....	70
Use Speed Call.....	71
Make a System Speed Call .....	72
Use Conference Hotline.....	73

### **While on an active call** **75**

---

Place a call on hold .....	75
Transfer a call .....	75
Use Attendant Recall .....	76
Use Call Park .....	77
Record a Calling Party Number .....	77
Display incoming calls .....	78
Trace a malicious call .....	78
Using Record On Demand key.....	79
Using SAVE key .....	79

### **Incoming calls** **81**

---

Activate Call Pickup .....	81
Use Call Waiting .....	82

### **While away from your desk** **85**

---

Use Call Forward .....	85
Use Internal Call Forward.....	86

### **Talk with more than one person** **87**

---

Use Call Join .....	87
---------------------	----

Set up a conference call .....	87
Use Conferee Selectable Display .....	88
Use Group Call .....	89

## **Work without interruption** **93**

---

Activate Make Set Busy .....	93
Call Deflect.....	93

## **Other call features** **95**

---

Use Call Page Connect to make an announcement .....	95
Use Centrex/Exchange Switchhook Flash .....	95
Charge a call or charge a forced call .....	96
Use Enhanced Override .....	98
Use Forced Camp-on .....	98
Use Privacy Release .....	99

## **Branch Office** **101**

---

Normal Mode .....	101
Local Mode .....	101
Troubleshoot Branch Office.....	101

## **Hospitality features** **103**

---

Activate Message Registration.....	103
Use Maid Identification .....	104
Display Room Status .....	105

## **Battery packs** **107**

---

Low battery indicators .....	107
Removing and inserting the battery pack .....	108
Charging your handset .....	108

## **Desktop Chargers** **110**

---

Single Charger .....	110
Using the Single desktop charger .....	111
Cleaning the Desktop Charger .....	111

<b>Dual Charger</b>	<b>113</b>
Using the Dual Charger .....	114
Cleaning the Dual Charger.....	114
<b>Quad Charger</b>	<b>116</b>
Using the Quad Charger.....	116
Cleaning the Quad Charger.....	117
<b>Terms you should know</b>	<b>119</b>





## Revision history

### June 2010

Standard 04.01. This document is up-issued to support Communication Server 1000 Release 7.0.

### May 2009

Standard 03.01. This document is up-issued to support Communication Server 1000 Release 6.0.

### January 2009

Standard 02.02. This document is up-issued to update technical content in the chapter Terms you should know to support Communication Server 1000 Release 5.5.

### December 2007

Standard 02.01. This document is up-issued to support Communication Server 1000 Release 5.5.

### November 2007

Standard 01.05. This document is up-issued to include new information about the Real-Time Location System (RTLS).

### July 2007

Standard 01.04. This document is up-issued to include new information added to the Handset Display Section, Selecting Phone Options.

### July 2007

Standard 01.03. This document is up-issued to include document feedback.

### June 2007

Standard 01.02. This document is up-issued to include new regulatory information.

### May 2007

Standard 01.01. This document is issued to support Communication Server 1000 Release 5.0.



# Regulatory and safety information

## European Union Directives Conformance Statement

---

This device complies with the essential requirements and other relevant provisions of directive 1999/5/EC. A copy of the Declaration may be obtained from [http://www.nortel.com/corporate/community/environment/life\\_cycle/declarations.html](http://www.nortel.com/corporate/community/environment/life_cycle/declarations.html) or Nortel Networks GmbH address: Ingolstaedter Strasse 14-18, 80807 Munich Germany.

## FCC Rules – Part 15

---

FCC registration number: IYG702X, IYG703X

This device complies with Part 15 of the FCC Rules. Operation is subject to the following two conditions: (1) This device may not cause harmful interference, and (2) this device must accept any interference received, including interference that may cause undesired operation.

FCC Radiation Exposure Statement: This portable device with its antenna complies with FCC's RF radiation exposure limits set forth for an uncontrolled environment. To maintain compliance this transmitter must not be co-located or operating in conjunction with any other antenna or transmitter.

## Industry Canada (IC) Notice

---

This device complies with RSS-210 of Industry Canada. Operation is subject to the following two conditions: 1) This device may not cause interference, and 2) this device must accept any interference, including interference that may cause undesired operation of the device.

Privacy of communications may not be ensured when using this telephone.

Certification Number IC: 2128B-702X, 2128B-703X



### WARNING

Changes or modifications to this equipment not approved by Nortel can cause this equipment to not comply with Part 15 of the FCC rules and void the user's authority to operate this equipment.



### CAUTION

This equipment contains no user-serviceable parts inside. Refer servicing to qualified service personnel.



### WARNING

- Follow standard acceptance procedures before operating the WLAN Handset 6120 and 6140 near life-support systems.
- To minimize risk of interference, pacemaker users should not carry the WLAN Handset 6120 and 6140 next to the pacemaker.
- Avoid placing the handset near small metallic objects. The handset earpiece attracts magnetic objects.
- The WLAN Handset 6120 and 6140 produce noise noticeable to hearing aid users. Use a headset compatible with hearing aids.
- The WLAN Handset 6120 and 6140 complies with Part 15 of the FCC Rules. Operation is subject to the following two conditions: (1) This device may not cause harmful interference, and (2) this device must accept any interference received, including interference that may cause undesired operation.
- Privacy of communications cannot be ensured when using the WLAN Handset 6120 and 6140.
- To prevent radio interference to the licensed service, the WLAN Handset 6120 and 6140 must be operated only indoors and kept away from windows to provide maximum shielding.

## Charger information

---

Charger models Nortel WLAN Handset 6100 Series Chargers (Single, Dual-slot and Quad-slot Charger models).

This equipment has been tested and complies with the limits for a Class A digital device, pursuant to Part 15 of FCC rules. These limits are designed to provide reasonable protection against harmful interference when the equipment is operated in a commercial environment. This equipment generates, uses, and can radiate radio frequency energy and, if not installed and used in accordance with the instruction

manual, can cause harmful interference to radio communications. Operation of this equipment in a residential area is likely to cause harmful interference in which case the user will be required to correct the interference at his own expense.

This Class A digital apparatus complies with Canadian ICES-003.

## Operational warnings

---



### WARNING

**For vehicles equipped with an air bag:** Do not place a portable radio product in the area over the air bag or in the air bag deployment area. An air bag inflates with great force. If a portable radio is placed in the air bag deployment area and the air bag inflates, the radio product can be propelled with great force and cause serious injury to occupants of the vehicle.



### WARNING

**Potentially explosive atmospheres:** Turn off your radio product prior to entering any area with a potentially explosive atmosphere, unless it is a radio product type especially qualified for use in such areas (for example, Factory Mutual Approved). Do not remove, install, or charge batteries in such areas. Sparks in a potentially explosive atmosphere can cause an explosion or fire resulting in bodily injury or even death.



### CAUTION

**Loud noise environment:** The WLAN Handset 6120 and 6140 are designed to produce optimal voice quality. However, when used in extremely loud noise environments (for example, close to working heavy machinery), users may experience degradation in call quality performance due to echo. Avoid using the handset when traversing these types of environments.

The areas with potentially explosive atmospheres referred to above include fueling areas such as below decks on boats, fuel or chemical transfer or storage facilities, areas where the air contains chemicals or particles such as grain, dust, or metal powders, and any other area where you are normally advised to turn off your vehicle

engine. Areas with potentially explosive atmospheres are often but not always posted.

**Batteries:** All batteries can cause property damage and/or bodily injury, such as burns, if a conductive material such as jewelry, keys, or beaded chains touch exposed terminals. The conductive material can complete an electrical circuit (short circuit) and become quite hot. Exercise care in handling any charged battery, particularly when placing it inside a pocket, purse, or other container with metal objects.

**Cleaning and drying considerations:** Aleather carrying case can help to protect the surfaces of the radio product and help prevent liquids (for example, rain) from entering into its interior. This product is not waterproof and exposing it to liquids can result in permanent damage.

## Electromagnetic interference and compatibility

---

**Attention:** Nearly every electronic device is susceptible to electromagnetic interference (EMI) if inadequately shielded, designed, or otherwise configured for electromagnetic compatibility.

### Facilities

To avoid electromagnetic interference and/or compatibility conflicts, turn off your radio product in any facility where posted notices instruct you to do so. Hospitals or health care facilities can be using equipment that is sensitive to external RF energy.

### Medical devices

**Pacemakers:** The Health Industry Manufacturers Association recommends that a minimum separation of 6 inches (15 cm) is maintained between a handheld wireless radio product and a pacemaker. These recommendations are consistent with the independent research by, and recommendations of Wireless Technology Research.



### WARNING

Persons with pacemakers should:

- always keep the radio product more than 6 inches (15 cm) from their pacemaker when the radio product is turned on
- not carry the radio product in a breast pocket
- use the ear opposite the pacemaker to minimize the potential for interference
- turn the radio product off immediately if they suspect the occurrence of interference.

**Hearing aids:** Some digital wireless radio products may interfere with some hearing

aids. In the event of such interference, consult your hearing aid manufacturer to discuss alternatives.

**US/Canada:** Hearing Aid Compatibility (HAC) as per FCC Part 68

**Other medical devices:** If you use any other personal medical device, consult the manufacturer of your device to determine if it is adequately shielded from external RF energy. Your physician may be able to assist you in obtaining this information.

**Use while driving:**

Check the laws and regulations on the use of radio products in the area where you drive. Always obey them. When using the radio product while driving:





- Give full attention to driving and to the road.
- Use handsfree operation, if available.
- Pull off the road and park before making or answering a call, if driving conditions so require.

**Handset operation normal position:** Hold the handset as you would any other telephone, with the earpiece to your ear and speak into the microphone. The internal antenna is then positioned properly.

**Handset operation body-worn position:** To maintain compliance with RF energy exposure guidelines, if you wear a handset on your body when transmitting, always use the handset with a Nortel-supplied accessory as described in the user guide for this handset. Nortel supplies belt clips, holsters, and lanyards for body-worn operation. Use of accessories not supplied by Nortel may cause the handset emissions to exceed RF energy exposure guidelines.

## International certifications

The table below shows the international certifications applicable to the WLAN Handset 6120 and 6140.

Canada (Safety)		<sup>1</sup> CAN/CSA-C22-2 No. 60950-1
Canada	Industry Canada RSS-210	IC: 2128B-702X IC: 2128B-703X
European Union		0681 
United States (Safety)		UL 60950-1
United States		Part 15

<sup>1</sup> TUV Rheinland of North America is a Nationally Recognized Testing Laboratory (NRTL) in the United States and is accredited by the Standards Council of Canada to test and certify products to Canadian National Standards. Clients can demonstrate compliance for both U.S. and Canadian markets through a single mark (cTUVus) on their product(s) which denotes compliance to U.S. and Canadian National Standards.



## DenAn regulatory notice for Japan

### Warning

Please be careful of the following while installing the equipment:

- Please only use the Connecting cables, power cord, AC adaptors shipped with the equipment or specified by Nortel to be used with the equipment. If you use any other equipment, it may cause "failures, malfunctioning or fire".
- Power cords shipped with this equipment must not be used with any other equipment. In case the above guidelines are not followed, it may lead to death or severe injury

### 警告

本製品を安全にご使用頂くため、以下のことにご注意ください。

- 接続ケーブル、電源コード、ACアダプタなどの部品は、必ず製品に同梱されております。添付品または指定品をご使用ください。添付品・指定品以外の部品をご使用になると故障や動作不良、火災の原因となることがあります。
- 同梱されております付属の電源コードを他の機器には使用しないでください。上記注意事項を守らないと、死亡や大怪我など人身事故の原因となることがあります。

## Specific Absorption Rate (SAR) information

Your WLAN Handsets 6120 and 6140 is a low-power radio transmitter and receiver. When it is on, it receives and also sends radio frequency (RF) signals. In August 1996, the Federal Communications Commissions (FCC) adopted RF exposure guidelines with safety levels for hand-held wireless telephones. Those guidelines are consistent with the safety standards previously set by both U.S. and international standards bodies:

- ANSI C95.1 (1992) American National Standards Institute
- NCRP—Report 86 (1986) National Council on Radiation Protection and Measurements
- ICNIRP (1996) International Commission on Non-Ionizing Radiation Protection;
- DHWC—Safety Code 6 Department of Health and Welfare Canada

These standards are developed by independent scientific organizations through periodic and thorough evaluation of scientific studies. The standards include a substantial safety margin designed to assure the safety of all persons, regardless of age and health. The exposure standard for wireless mobile phones employs a unit of

measurement known as the Specific Absorption Rate (SAR). The SAR limit set by the FCC is 1.6W/kg. Tests for SAR are conducted by using standard operating positions specified by the FCC with the telephone transmitting at its highest certified power level in all tested frequency bands. Although the SAR is determined at the highest certified power level, the actual SAR level of the telephone while operating can be well below the maximum value. This is because the telephone is designed to operate at multiple power levels so as to use only the power required to reach the network. In general, the closer you are to a wireless Base Station antenna, the lower the power output. Before a telephone model is available for sale to the public, it must be tested and certified to the FCC that it does not exceed the limit established by the government-adopted requirement for safe exposure. The tests are performed in positions and locations (e.g., at the ear and worn on the body) as required by the FCC for each model. While there may be differences between the SAR levels of various telephones and at various positions, they all meet the government requirement for safe exposure.

The FCC has granted an Equipment Authorization for this model phone with all reported SAR levels evaluated as in compliance with the FCC RF emission guidelines. SAR information on this model telephone is on file with the FCC and can be found under the Display Grant section of <http://www.fcc.gov/oet/fccid> after searching on FCC ID IYG702X or FCC ID IYG703X.

Additional information on Specific Absorption Rates (SAR) can be found on the Cellular Telecommunications Industry Association (CTIA) website at <http://www.ctia.org/>.

The only authorized headsets that may be utilized with the Nortel WLAN Handset 6120 or 6140 are those obtainable from Nortel Networks or its reseller partners.

FCC SAR peak values (in W/kg):

<b>Frequency</b>	<b>6120-head</b>	<b>6120-body</b>	<b>6140-head</b>	<b>6140-body</b>
2.4 GHz	0.23	0.16	0.22	0.19
5.2 GHz	0.36	0.37	0.39	0.40
5.4 GHz	0.35	0.39	0.40	0.37
5.8 GHz	0.37	0.20	0.28	0.27

EU SAR peak values (in W/kg):

<b>Standard</b>	<b>Frequency</b>	<b>6120 head</b>	<b>6120 body</b>	<b>6140 head</b>	<b>6140 body</b>
802.11b		0.119	0.093	0.114	0.104
802.11g		0.059	0.048	0.046	0.039
802.11a	(5150–5250 MHz)	0.090	0.147	0.091	0.164
802.11a	(5250–5350 MHz)	0.043	0.113	0.051	0.095
802.11a	(5470–5725 MHz)	0.356	0.156	0.088	0.153



## Your WLAN Handset 6120 and 6140

This section describes the WLAN Handset 6120 and 6140 and their features when operating on Nortel Communication Server 1000. The WLAN Handset 6120 and 6140 are fully functional handsets specifically designed for the busy office environment.

**Note:** Not all features described in this guide are available on all handsets. Consult your system administrator to verify which features are available for your use.



### WARNING

- To minimize risk of interference, pacemaker users should not carry the WLAN Handset 6120 and 6140 next to the pacemaker.
- Avoid placing the handset near small metallic objects. The handset earpiece attracts magnetic objects.
- The WLAN Handset 6120 and 6140 produce noise noticeable to hearing aid users. Use a headset compatible with hearing aids.
- This device complies with Part 15 of the FCC Rules. Operation is subject to the following two conditions: (1) this device cannot cause harmful interference and (2) this device must accept any interference received, including interference that can cause undesired operation.

WLAN Handset 6120 and 6140

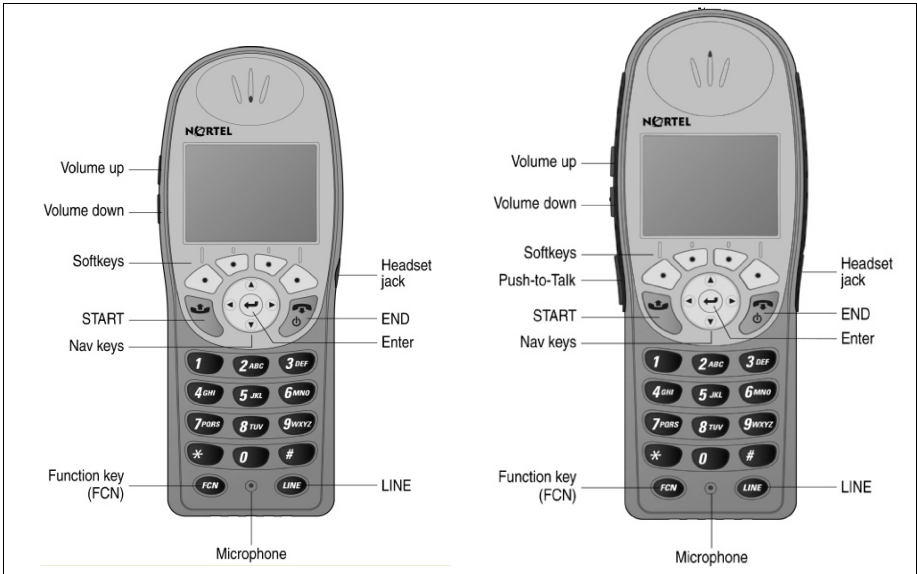

## Handset controls and descriptions



Press and hold the **End** button to turn your WLAN Handset 6120 and 6140 off. Pressing the End button also turns the handset on.

This key also affects some of the states of the handset.



Press the **End** button to terminate an active call.

Press the **Start** button to place a call.



Press the **Line** button to access the key labels for line appearances and line features.

**Attention:** **Line** emulates the six feature keys on a IP Phone 2004 desktop telephone.

**Attention:** All features activated by **Line** are locally programmed and may or may not be available in any given facility

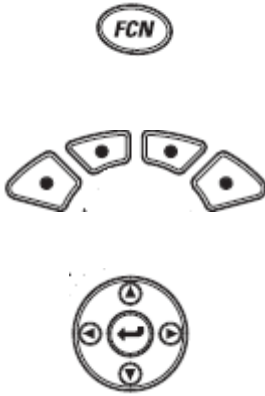











Press **FCN** to open the Features list when in the active (idle) state. Other handset functions are accessed via the **Actv** soft key.

**Soft keys (self-labeled)** are located below the display area. The liquid crystal display (LCD) indicator above the key changes, based on the state of the handset. Use the four soft keys to activate the displayed soft key feature.

Use the **Nav** buttons and **Enter** to navigate and activate the various menu options.

## Status indicators

Indicator	Function
	<p>These symbols give a visual indication (from weak to strong) of the signal strength to the handset.</p>
	<p>You have a new voicemail message.  <i>Note:</i> You may also hear an audio Message Waiting Indicator (stutter or beeping dial tone) when you go off-hook.</p>
	<p>The battery icon indicates the amount of charge that remains in the battery pack. When only one level remains, the battery pack must be recharged.</p>
	<p>The speakerphone icon displays when the speakerphone is active.</p>
	<p>The Line Indicator area displays the line currently in use. Any lines which are not idle or active (for example, if the line is on hold or forwarded) have a plus sign (+) in front of the entry for that line.</p>
	<p>Up and down arrows are displayed when the menu has additional options above or below. Left or right arrows are displayed during editing when the cursor can be moved left or right.</p>
	<p>The telephone ring icon indicates a regular incoming telephone call.</p>
	<p>The messaging ring icon indicates an incoming call from a Messaging application.</p>
	<p>The push-to-talk (PTT) ring icon indicates an incoming PTT call.</p>
	<p>The priority PTT ring icon indicating an incoming call on the priority PTT channel. This call overrides any other calls.</p>
<b>Muted</b>	<p>The muted indicator is displayed after the Mute soft key is pressed. It indicates that the microphone is not transmitting sound. Press the Mute soft key again to unmute the microphone.</p>
<b>Locked</b>	<p>The locked indicator is displayed when the keypad is locked.</p>



**No Service**

The no service indicator indicates that you are out of the coverage area and cannot receive or place calls. The out-of-service tone plays. Return to the coverage area to reestablish the connection.



The download icon indicates that the handset is downloading code. This icon only appears while the handset is running the over-the-air downloader. It appears to the right of the signal strength icon in the same location as the voicemail icon.



The ring indicator icon is used to display the Real-Time Location System (RTLS) icon, indicating that the administration option has been set to ON. An incoming call, triggering the ring indicator icon, takes priority over the RTLS icon.

## Modes of operation

---

The WLAN Handset 6120 and 6140 have six modes of operation (see Table 1).

**Table 1**

**The WLAN Handset 6120 and 6140 Modes of operation (Part 1 of 2)**

Mode	Description
<b>Standby</b>	This is the normal state when the handsets are online but inactive. In the standby state, the handset can receive calls and access the User Option menu. To perform other operations, the handsets must be active (off-hook). The standby state uses less power than the active (idle) state.
<b>Active</b>	This is equivalent to a regular telephone being off-hook. The handsets go to the active (off-hook) state when you press <b>Start</b> when the handsets are in the standby or active (idle) state. When in the active (off-hook) state, the handsets use a soft ring.
<b>Active idle</b>	The soft key display area is active but there is no dial tone. From the standby mode, press the <b>Actv</b> soft key to enter the active idle mode and display available soft keys.
<b>Config Menu</b>	User preferences are accessed in the Config Menu. In this mode the handsets are on, but cannot receive calls.

**Table 1**  
**The WLAN Handset 6120 and 6140 Modes of operation (Part 2 of 2)**

Mode	Description
<b>Message Alert</b>	Custom text messaging applications can be programmed for your facility. This mode is activated through <b>FCN+8, 9, # or *</b> if programmed..
<b>Push-to-talk (PTT)</b>	This feature is only available in the WLAN Handset 6140. The WLAN Handset 6140 uses channels for incoming and outgoing radio communication. While PTT is active, the handset is in PTT mode.

## Menu navigation

The navigation keys (Nav keys) located below the soft keys are used to navigate through menu options. These keys are referred to in this guide as **Nav** keys (**Nav▲**, **Nav▼**, **Nav◀**, **Nav▶**) and **Enter**.

**Figure 1**  
**Menu navigation**



## Shortcut Keys

When a menu is displayed, a shortcut key can be displayed on the right edge of the menu line. Press the corresponding number on the keypad to activate the corresponding menu option.

## Handset Displays

The top row of the display provides status indicators for various handset conditions. It is referred to as the status bar.

The middle row displays information about the handset identity, user profile, calls in progress, menu options, and data from the telephone.

The bottom row displays soft key labels.

Figure 2 Standby soft key display

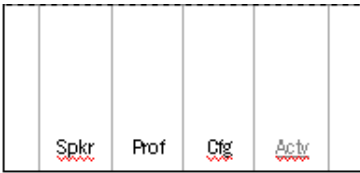
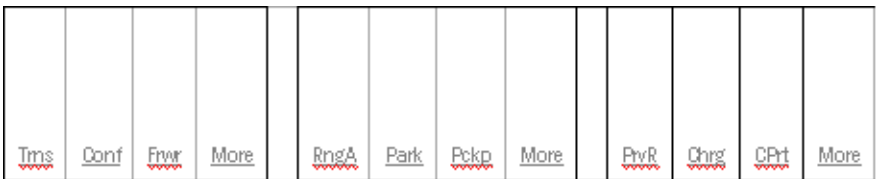

Figure 3 Active Idle and Active soft keys display



## Feature Activation displays

The handset enters Active Idle mode when **Actv** is pressed from standby mode, displaying feature activation soft keys. These soft keys also display during an active call.

When **FCN** is pressed during active idle mode or while in an active call, the soft key labels shown below display additional features that can be activated for call handling.

Additionally, when **FCN** is pressed during active or active idle mode, a Feature List displays that lists features that have been configured for your facility. The **Exit** soft key or **END** returns to the previous display.

Features may also be programmed to the **Line** key. Press **Line** when in active mode to view the list of features that have been programmed for your facility. **Line** features are explained later in this text.



## Soft key labels

The bottom row of the display shows labels that are associated with the four soft keys just below it. When a soft key is active, a label appears to describe its function. If you press the soft key, the feature is activated. When additional soft keys are available, the **More** soft key displays. Press **More** to view additional soft key labels.

The following table shows some of the soft keys that are available.

**Table 2**  
**WLAN Handset 6120 and 6140 soft key labels**

Soft key label	Description	Action
<b>Back</b>	Go Back	Returns to the previous menu display.
<b>CAPS caps</b>	Change case	Toggles to allow a change in case when you enter alphabetical text.
<b>Clr</b>	Clear	Deletes the entry.
<b>Cncl</b>	Cancel	Returns to the previous menu display without saving any data that is entered.
<b>Del</b>	Delete	Deletes the character to the left of the cursor.
<b>Done</b>	Finished	Exits a list when more than one selection is possible.
<b>Exit</b>	Exit	Exits the menus.
<b>Hold</b>	Hold	Places a call on hold.
<b>Cfg</b>	Configure	Opens the config menu.
<b>Mute</b>	Mute	Toggles to mute or unmute the microphone.
<b>No</b>	Negative reply	Press to reply <b>No</b> to a displayed question.
<b>Play</b>	Play	Plays the selected ring tone.
<b>Prof</b>	Profile	Opens the profile menu.
<b>Redl</b>	Redial	Displays a list of the last 10 numbers entered.
<b>Spdc</b>	Speed-dial call	Opens the list of speed-dial numbers.

**Table 2**  
**WLAN Handset 6120 and 6140 soft key labels**

Soft key label	Description	Action
<b>Spkr</b>	Speakerphone	Toggles the speakerphone function.
<b>Lock</b>	Lock keys	Press <b>Cfg + Enter</b> , to lock the keypad.
<b>Unlk</b>	Unlock keys	Press <b>Cfg + Unlk</b> to unlock a locked keypad.
<b>USB</b>	Active USB	Displays when the handset is being configured by the USB port of the dual charger.
<b>Yes</b>	Positive reply	Press to reply <b>Yes</b> to a displayed question.

## Cleaning your handset

The WLAN Handset 6120 and 6140 occasionally need to be cleaned to maintain appearance. In general, wiping the handset surface with a plain-water-dampened cloth or paper towel removes most films or residues.

If more rigorous cleaning is required, you can use:

- A mild detergent solution. Be sure to wipe away any detergent residue with a plain-water-dampened cloth.
- Any general-purpose household glass and surface cleaner. A spray cleaner may be used with care. Do not spray at an angle. Do not allow liquid cleaners to seep into keypad. Be sure to wipe away any detergent residue with a clean water-dampened cloth. Do not immerse. Spray the cleaner on a soft cloth or paper towel and then wipe the handset.
- Pre-treated cloths, like those used for eyeglasses or cameras.
- Pre-moistened towelettes. Avoid those containing lanolin or aloe as it leaves a slippery residue.
- Isopropyl alcohol, applied by a damp cloth or paper towel. When you use alcohol, do not rub the keypad characters vigorously, as this significantly

degrades legibility.

### ATTENTION

- Do not use furniture polishes, waxes, or plasticizer-based cleaner.
- Do not use lanolin, aloe, glycerin, or other skin care products.
- Do not apply any solvent such as acetone or mineral spirits.
- Do not directly spray or immerse the handset.

If the headset connector is dirty, you can experience a scratchy or intermittent signal. To clean the connector, dip the padded end of a cotton swab in isopropyl alcohol. Gently insert in the connector and twist, repeating several times. If available, blow compressed air into the connector to clear debris.

## Care of your handset

To ensure proper care of your handset:

- Avoid dropping the handset or knocking it against hard surfaces. To protect the handset, carry it in a holster or carrying case.
- Do not open the handset or disassemble the charger. Either of these actions will void your warranty.
- Turn off the handset and unplug the charger before cleaning. Do not exert undue pressure on the electrical contacts of the charger while cleaning.
- Keep the headset jack covered when not in use.
- Use a carrying case to help protect the surfaces and to help prevent liquids, for example, rain from entering into the interior of the handset.
- If your handset gets wet, follow the procedure below:
  - 1 Power off the handset.
  - 2 Remove the battery pack from the handset.
  - 3 Shake excess liquid from the handset.
  - 4 Place the handset and battery pack in an upright position in a dry, well ventilated area.
  - 5 Allow the handset and battery pack to dry for 72 hours before you reconnect the battery pack and power on the handset.

If the handset still does not work, contact your phone system administrator for assistance.

## Basic handset operation

Attention: Press **End** to disconnect from a previous call.

### Powering on and off the WLAN Handset 6120 and 6140

---

To power on/off the handset:



Press **End** to turn on. Press and hold **End** to turn off.

### Locking the keypad

---

Press **Cfg** + **Enter** to manually lock the keypad.

### Unlocking the keypad

---

Press **Unlk** + **#** to unlock the keypad.

### Making an internal call

---

To make an internal call



1. Press **Start** and wait for a dial tone.
2. Enter the internal extension.

### Making an external call

---

To make an external call



1. Press **Start** and wait for a dial tone.
2. Enter the external number.

## Selecting a line

---

To select a line



If multiple lines are available, your telephone system can require you to select a line before you enter a number.

1. Press the **Line** button.
2. Press the number key that corresponds to the desired line. You will hear a dial tone.

## Entering a number

---

To enter a number

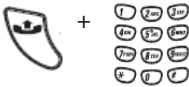

1. While the handset is in standby mode, press **Start**.
2. Listen for the dial tone.
3. Press the number pad to enter the number.

## Redialing a number

---

To redial a number

1. While the handset is in standby mode press the **Actv** soft key.
2. Press the **Redl** soft key.

A list of recently-called numbers is displayed.

3. Use the **Nav** keys to select the number you wish to redial.
4. Press the **Dial** soft key.

## Answering a call

---

The handset rings or vibrates to alert you of an incoming call. A line indicator on the display shows the caller's name and extension.



To answer a call



1. Press **Start** and hold the earpiece to your ear.
2. Alternatively, activate the speakerphone by selecting the **spkr** soft key.

## Answering a call on a second line

---

If you are on a call and hear subdued ringing, a call is incoming on a second line. The line number on the display is flashing.

1. Press **FCN**.
2. Place your first call on **hold**.
3. Press **Line**.
4. Scroll using the **Nav** keys to select the line displaying the incoming call.
5. Press **Enter** to answer the call.

## Muting the microphone

---

To mute the microphone



Your **Mute** functionality is enabled or disabled by your system administrator. Contact your system administrator to determine if your **Mute** key is enabled.

If your **Mute** functionality is enabled, press the **Mute** key to listen to the receiving party without transmitting. Press the **Mute** key again to return to two-way conversation.

**Note:** If your **Mute** key is not enabled, pressing the **Mute** key places the call on hold. Press the **Mute** key again to restore the active call or press the line key to restore the active call. You cannot retrieve this call from hold by pressing the Hold key.

Press **FCN + Mute**.

## Placing a call on hold

---

To place a call on hold

Press **FCN + Hold**.



## Resuming a held call

---

To resume a held call

Press **LINE** and then press the line number key.



## Hanging up

---

To hang up a call

Press **End**.

To return to the standby mode, do this action at the end of each call.



## Adjusting the speaker volume

---

To adjust the speaker volume

Press **volume up/down** on the side of the handset during the call.

## Changing the ring volume

---

To change the ring volume

Press **volume up/down** on the side of the handset while the phone is ringing. The default ring volumes are set in the User Profile menus.

## Silencing the ringing

---

To silence the ringing



Press **End** to silence the ring.

## Opening the speed-dial list

---

To open the speed-dial call list

1. Press **Actv.**
2. While the handset is in standby mode, press the **Spdc** soft key.

## Activating the speakerphone

---

To activate the speakerphone

Press the **Spkr** soft key and speak into the handset. Note that this feature may not be activated at your facility.

## Answering using the headset

---

To answer using the headset

Press any key (other than **End**) to answer a call when the headset is plugged in.

## Adjusting the headset volume

---

To adjust the headset volume

Press **volume up/down** on the side of the handset during the call.

## Changing the user profile

---

To change the user profile

1. While the handset is in standby mode, select the **Prof** soft key.
2. To select a new profile, scroll up or

down using the **Nav** keys and press **Enter**.

## Opening the Personal Directory

---

### To open the Personal Directory

1. While the handset is in the inactive state, select **FCN**.
2. Using the navigation keys, navigate to **Directories** and press **Enter**.
3. Continue to navigate to **Personal Directories** and press **Enter**.
4. Navigate to the number you wish to call.
5. Press the **Dial** soft key.

## Displaying additional features

---

### To display additional features



During a call, press **FCN** to display additional features that are customized for your facility.

## Turning on the backlight

---

### To turn on the backlight

The backlight illuminates when any key is pressed or when there is an incoming call, and stays on for 10 seconds. If another key is not pressed within 10 seconds, the backlight automatically turns off.

# Advanced features

## Facility-specific features

---

Press **FCN** while off-hook to display the menu of advanced telephone features available at your facility. Features can be activated by pressing the corresponding shortcut key or by scrolling up and down using the **Nav** keys to highlight the option and pressing **Enter**.

## Speakerphone

---

Your system administrator can enable or disable the speakerphone mode. If the speakerphone is enabled, it is activated by selecting the **Spkr** soft key. Select **Spkr** again to end speakerphone mode. The audio transfers to the handset earpiece. When speakerphone is disabled, **Spkr** does not appear as a soft key label.

## Redial

---

**Redl** is available in the standby mode. When **Redl** is selected, a list of the last 10 outgoing calls are displayed. Scroll using the **Nav** keys to highlight the number and then press **Start** to enter the number.

## Personal Directory

---

The Personal Directory in your WLAN Handset 6120 and 6140 can store up to 20 user-defined numbers. Open the Personal Directory list by selecting **FCN** from the inactive state and use the navigation keys. You can add, delete, or edit an entry in the Personal Directory.

The Personal Directory list is sorted alphabetically. If the system speed-dial call key is programmed, it is listed as the first entry with a greater-than (>) symbol as the first character. Only the system administrator can change this entry. The <new> option appears until the maximum number of entries is entered.

## Real-Time Location System

---

The Real-Time Location System (RTLS) is a feature on the WLAN 6120 and 6140 Handsets enabling location tracking and monitoring of the device. Your system administrator turns this function ON or OFF. When the RTLS is turned ON, this information is displayed as an icon on a map of a selected area, such as an office

interior.

The Ring Indicator icon location on the handset displays the RTLS icon, and indicates that the RTLS administration option has been set to ON. When a call comes in, the ring indicator replaces the RTLS icon.

When you are in the Config Menu and a call comes in, the RTLS icon starts blinking on the top of the screen. There are two ways to get the phone to ring from this point:

1. Leave it alone and in 20 seconds the Config Menu will time out and the phone will return to the idle screen and start ringing.
2. Press END or the Exit soft key to exit the Config Menu (because you noticed the flashing phone icon) and the phone will return to the idle screen and will start ringing.

At this point, the phone can be answered by pressing the START (offhook) key. If desired, you can answer the call immediately without pressing END/Exit or letting the menus timeout.

## Speed-dial call

---

You can use your WLAN Handset 6120 and 6140 to assign up to 10 speed-dial call keys to numbers in the Personal Directory.

From standby mode, open the speed-dial call list by selecting the **Spdc** soft key. If programmed, the first item on this list is the system-wide speed-dial call number set by the system administrator. It is marked with a greater-than (>) symbol on the left side of the row. It is usually reserved for emergency situations.

To place a speed-dial call, press and hold the corresponding key for one second. The system speed-dial key must be pressed for three seconds. The handset displays the name and number for one second before it dials the call. You can press **End** during this second to terminate the call.

Alternatively, you can scroll using the **Nav** keys to highlight a number or listing and press **Start** or **Spkr** to enter the number. Press **Exit** to return to standby mode.

A Personal Directory entry number can be assigned to a speed-dial key from the speed-dial list. Select the speed-dial call key that you wish to assign and press **Set** to open the Personal Directory list. Use the **Search** feature or scroll using the **Nav** keys to select the desired entry.

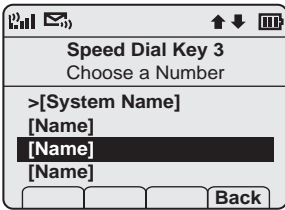

Press **Enter** to assign the selected name to that speed-dial call key. Press **Back** to return to the speed-dial call list. You can edit speed-dial call entries through the Personal Directory, as described above.

## The Config Menu

When the handset is in standby mode, press the **Cfg** soft key to enter the Config Menu. The handset cannot make or receive calls while in the Config Menu. You can set your user preferences in the Config Menu.

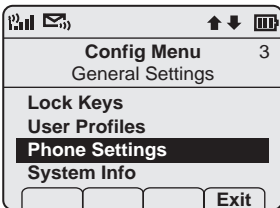

Scroll through the menu options using the **Nav** keys. When an asterisk (\*) appears to the left of an option, it indicates that the option is selected. Press **Exit** to return to standby mode. Press **Back** to return to the previous menu.

## Config Menu options

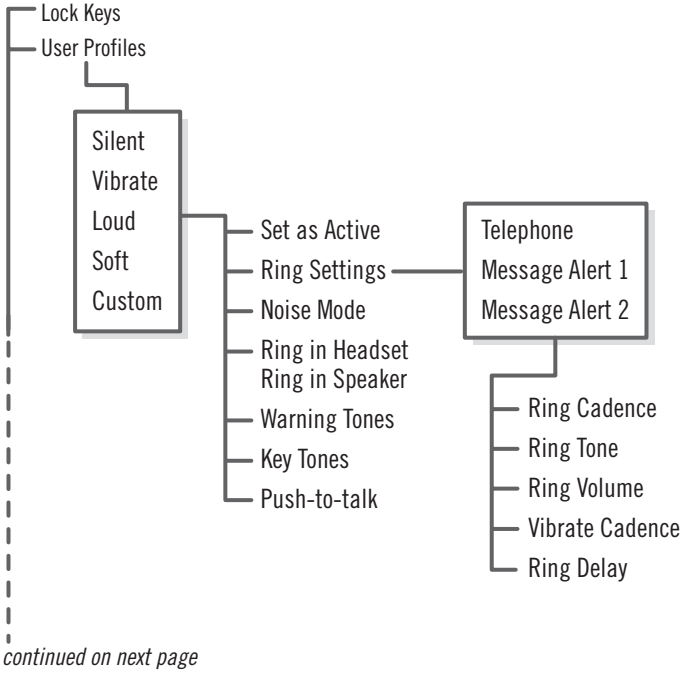



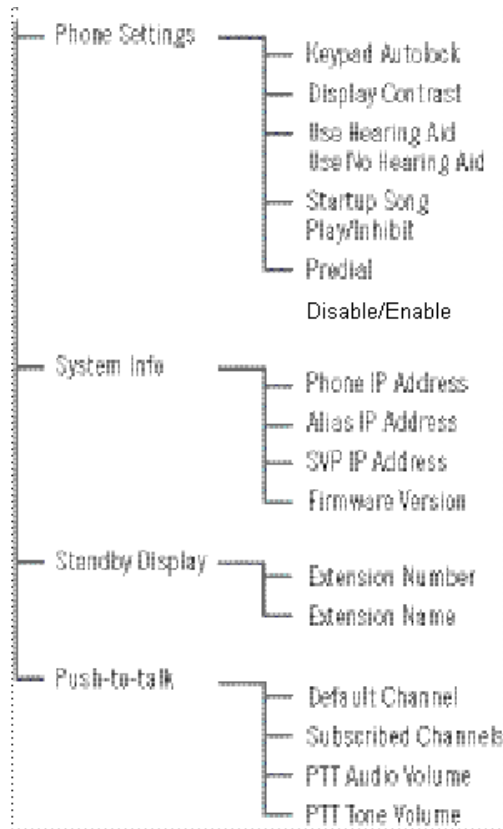

## User-profiles

Your handset ring behavior is established by five User Profiles:

- Silent
- Vibrate
- Loud
- Soft
- Custom

The currently-active user profile is shown on the standby display. While the handset is in standby mode, you can change the ring behavior by pressing **Prof** and selecting a new profile from the list. The currently-active profile is marked with an asterisk (\*).

To change the ring-tone or any other ring setting for any profile, go to **User Profiles** and select the profile, and then select **Ring Settings** and **Telephone Ring** for standard phone calls or one of the **Message Alerts** for text message. Then, select the ring option that you want to adjust.

## Default profile settings

---

Setting/Profile	Silent	Vibrate	Soft	Loud	Custom
Ring Cadence	Off	Off	Telephone	Telephone	Telephone
Ring Tone	Tone 1	Tone 1	Tone 1	Tone 1	Tone 1
Ring Volume	1	1	3	7	5
Vibrate Cadence	Off	Telephone	Off	Off	Telephone
Ring Delay	0	0	0	0	5
Noise Mode	Normal	Normal	Normal	Normal	Normal
Headset/Speaker	Speaker	Speaker	Speaker	Speaker	Speaker
Key Tones	Off	Off	On	On	On
Warning Tones	Off	Off	On	On	On
Push-to-talk*	Off	Off	On	On	On

\*Push-to-talk is available only on the WLAN Handset 6140 .

To reset all user profiles to the default settings, contact your system administrator.

## Data entry and editing

---

Enter number by pressing the keypad buttons. The blinking underscore, identifies the cursor position. To enter alphanumeric strings, **CAPS/caps** is displayed and can be used to toggle the case. Enter letters by repeatedly pressing the corresponding key until the desired letter is displayed on the screen. Use **CAPS** to change the case as needed.

### To edit during entry

1. Press **Del** to delete the character to the left of the entry.
2. Press **Clr** to delete an entry.
3. Enter the new data.

### To edit an existing entry

1. Scroll using the **Nav** keys to move the cursor position.

2. Press **Del** to delete the character to the left.
3. Insert new data by using the buttons on the keypad.

## Alphanumeric Entries

---

**Table 3**  
**Alphanumeric entries**

Key	caps	CAPS
1		1
2	2abc	2ABC
3	3def	3DEF
4	4ghi	4GHI
5	5jkl	5JKL
6	6mno	6MNO
7	7pqrs	7PQRS
8	8tuv	8TUV
9	9wxyz	9WXYZ
0	0	0
*	* . - _ ! \$ % & ' ( ) + , : ; / \ = @ ~	
#	# <space>	

## Push-to-talk

---

This feature is available only on the WLAN Handset 6140.

In PTT mode, the WLAN Handset 6140 can be used in a group broadcast mode in which the handsets operate like walkie-talkies, and in which a single handset can transmit to multiple listeners.

Push-to-talk (PTT) is enabled by the system administrator and set up by the user using the Config Menu. See Config Menu options for details about setting up the PTT. If the system administrator disables the PTT, the PTT options do not appear in the Config Menu.

### To initiate a PTT call

1. Press **Push-to-talk**.

Wait for the display to show **Transmitting**.

2. Speak into the microphone.

All WLAN 6140 handsets that are monitoring the channel can hear the transmission.

### To respond to a PTT call

Press **Push-to-talk** during the 10 second wait period.

### To select a different PTT channel

1. Press and release **Push-to-talk**.
2. Select a new channel from the list by scrolling using **Nav** keys.

### To end one PTT call and start another call

1. Press **End** to exit the PTT call.
2. Press **Push-to-talk** and select a different channel from the list.
3. Press **Push-to-talk** to begin to transmit on the new channel.

### To receive a PTT call while in a telephone call

1. Press **End** to end the telephone call.
2. You hear the PTT call.

### To subscribe to additional PTT channels

1. Open the Config Menu and select **Push-to-talk (PTT)**.
2. Select **Subscribed Channels**.
3. Select the channel that you want to add. Subscribed channels are marked with an asterisk (\*).

### To transmit on the priority channel

1. Press **Push-to-talk**.
2. Select the priority channel from the list.

**To end a PTT call****To change PTT volume****To answer a call during a PTT transmission****To start a telephone call during a PTT transmission****To turn off PTT**

3. Press **Push-to-talk** and then speak.

Press **End** to exit the PTT call.

Use the **Up** and **Down** volume buttons located on the side of the handset.

Press **Start**. The PTT transmission is preempted by the telephone call.

1. Press **Start**.
2. Enter the number that you wish to call. The PTT transmission is preempted during the telephone call.

Change to a different profile. Silent and Vibrate disable PTT by default, or unsubscribe from all PTT channels.

## Security

Your handset is preprogrammed by the system administrator for the type of security you need. For more information, talk to your system administrator.

**ATTENTION!**

Do not change the security level through your handset.

## The headset

Nortel offers optional headsets (depending on market region) for use in noisy environments or if you need to have your hands free while talking.

To use the headset, plug it into the jack on the bottom of the handset. The headset is specifically designed for the WLAN Handset 6120 and 6140.

When you receive a call using a headset, the headset and the handset ring.

Use only authorized headsets with WLAN Handset 6120 and 6140.





## Handset display

This section summarizes the display features of the WLAN Handset 6120 and 6140.

**Figure 4**  
**WLAN Handset 6120 and 6140 display**

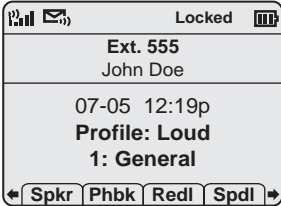

The WLAN Handset 6120 and 6140 have three display areas:

- The top row of the display provides status indicators for various handset conditions. It is referred to as the *status* bar.
- The middle section displays information about the handset identity, user profile, calls in progress, menu options, and data from telephone.
- The lower display area shows the soft key labels.

## User Option menu

---

When the WLAN Handset 6120 and 6140 are in standby mode (power is on, but the handset is not in use), press the **Cfg** button to display the User Option menu.

This section describes the following standard User Option menu items:

- Lock Keys
- Language
- Ring Options
- Phone Options
- System Info
- Extension

Check with your system administrator for the specific features that are supported by your WLAN Handset 6120 and 6140.

## Locking the Keypad

---

You can lock the handset by using the Lock Key menu.

### To lock the keypad

1. While the handset is in the standby mode, press the **Cfg** soft key.
2. Use the **Nav** keys to scroll through the feature menu and highlight the **Lock Keys** feature.
3. Press **Enter** to lock the keypad.

### To unlock the keypad

1. While the handset is in standby mode, press the **Unlk** soft key.
2. Press **#** to unlock the keypad.

## Selecting a Language

---

For systems that support multiple languages, you can select the display language from a list of supported languages.

If the Language setting is password-protected, you must enter a password (SCPW) to change the language. If you enter an incorrect password, an error message is displayed. If you enter an incorrect password more than three times, the password functionality is locked. Contact your system administrator to unlock the password.

### To change the language

1. While the handset is in standby mode, select the **Cfg** soft key.
2. Use the **Nav** buttons to scroll through the menu and highlight **Languages**.
3. Press **Enter**.
4. Use the **Nav** buttons to scroll through the menu and highlight the desired language.
5. Press **Enter**.

6. Do one of the following:
  - Press **back** to return to the previous menu and choose another option.
  - Press the **End** button to exit all menus and return to the standby state.

## Selecting Ring Options

---

Phone Options presents a menu of choices:

- Telephone Ring — presents a submenu of choices that you can set:
  - Ring Cadence
  - Ring Tone (see the following note 1)
  - Ring Volume
  - Vibrate Cadence
  - Ring Delay (see the following note 2)
- Message Alert 1 — reserved for future use.
- Message Alert 2 — reserved for future use.

**Note 1:** Ring Tone does not appear in the menu when Ring Cadence is off.

**Note 2:** Ring Delay does not appear in the menu when Ring Cadence or Vibrate Cadence is off.

### To select Ring Cadence

1. While the handset is in standby mode, select the **Cfg** soft key.
2. Use the **Nav** keys to scroll to **User Profiles**.
3. Press **Enter** to select **User Profiles**. The next menu level is displayed.
4. Use the **Nav** keys to scroll through the menu and highlight one of the settings. (an asterisk [\*] indicates the selected/active setting).

5. Press **Enter** to select the option.
6. Use the **Nav** keys to scroll to **Ring Settings**.
7. Press **Enter** to select the option.
8. Use the **Nav** keys to select **Telephone Ring**.
9. Press **Enter** to select the option.
10. Use the **Nav** keys to scroll to **Ring Cadence** and select one of the following:
  - Off
  - PBX — This is the default.
  - Continuous
  - Short Pulse
  - Long Pulse
11. Press **Enter** to choose the cadence.
12. Do one of the following:
  - Press **Back** to return to the previous menu and choose another option.
  - Press the **End** button to exit all menus and return to the standby state.

### To select Ring Tone

Ring Tone does not appear in the menu when Ring Cadence is off.

1. While the handset is in the standby mode, press the **Cfg** soft key.
2. Use the **Nav** keys to scroll to **User Profiles**.
3. Press **Enter** to select **User Profiles**. The next menu level is displayed.

4. Use the **Nav** keys to scroll through the menu and highlight one of the settings (an asterisk [\*] indicates the selected/active setting).
5. Press **Enter** to select the option.
6. Use the **Nav** keys to scroll to **Ring Tone**.
7. Press **Enter** to select the option.
8. Use the Nav keys to select **Telephone Ring**.
9. Press **Enter** to select the option.
10. Use the **Nav** keys to scroll through the menu and select **Ring Tone**.
11. Press **Enter** to select the option.
12. Use the **Nav** keys to scroll through the list and to highlight one of the following:
  - Tone 1 — This is the default
  - Tone 2
  - Tone 3
  - Tone 4
  - Tone 5
13. To play the highlighted setting, press **Play**.
14. Press **Enter** to choose the tone.
15. Do one of the following:
  - Press **Back** to return to the previous menu and choose another option.

- Press the **End** button to exit all menus and return to the standby state.

### To select Ring Volume

1. While the handset is in the standby mode, press the **Cfg** soft key.
2. Use the **Nav** keys to scroll to **User Profiles**.
3. Press **Enter** to select **User Profiles**. The next menu level is displayed.
4. Use the **Nav** keys to scroll through the menu and highlight one of the settings. (an asterisk [\*] indicates the selected/active setting).
5. Press **Enter** to select the option.
6. Use the **Nav** keys to scroll to **Ring Setting**.
7. Press **Enter** to select the option.
8. Use the **Nav** keys to select **Ring Volume**.
9. Press **Enter** to select the option.
10. Do one of the following:
  - Press the **Back** to return to the previous menu and choose another option.
  - Press the **End** button to exit all menus and return to the standby state.

### To select Vibrate Cadence

1. While the handset is in standby mode, press the **Cfg** soft key.

2. Use the **Nav** keys to scroll to **Use Profiles**.
3. Press **Enter** to select the **Use Profiles**. The next menu level is displayed.
4. Use the **Nav** keys to scroll through the menu and highlight one of the settings (an asterisk [\*] indicates the selected/active setting).
5. Press **Enter** to select the option.
6. Use the **Nav** keys to scroll to **Vibrate Cadence**.
7. Press **Enter** to select the option.
8. Use the **Nav** keys to highlight one of the following:
  - Off — This is the default.
  - PBX
  - Continuous
  - Short Pulse
  - Long Pulse
9. Press **Enter** to choose the cadence.
10. Do one of the following:
  - Press **Back** to return to the previous menu and choose another option.
  - Press the **End** button to exit all menus and return to the standby state.

### To select Ring Delay

Ring Delay does not appear in the menu when Ring Cadence or Vibrate Cadence is turned off.

1. While the handset is in standby mode, press the **Cfg** soft key.
2. Use the **Nav** keys to scroll to **User Profiles**.
3. Press **Enter** to select **User Profiles**. The next menu level is displayed.
4. Use the **Nav** keys to scroll through the menu and highlight one of the settings (an asterisk [\*] indicates the selected/active setting).
5. Press **Enter** to select the option.
6. Use the **Nav** keys to scroll to **Ring Delay**.
7. Press **Enter** to select the option.
8. Use the **Nav** keys to highlight one of the following:
  - No Delay — This is the default.
  - 5 Second Delay
  - 10 Second Delay
9. Press **Enter** to choose the delay.
10. Do one of the following:
  - Press **Back** to return to the previous menu and choose another option.
  - Press the **End** button to exit all menus and return to the standby state.

## Selecting Phone Options

---

Phone Options presents a menu of choices:

- **Noise Mode** — enables the user to adjust the handset for different levels of



noise within the work environment. Changing the Noise Mode to High or Severe adjusts the handset's microphone and in-ear speaker volume to account for background noise. Select Normal: for most office environments; High: for moderate background noise; or Severe: for extremely noisy conditions. If you use High or Severe modes in a quiet environment, your caller may find it difficult to hear your voice.

**Note:** Setting the Noise Mode to High or Severe also increases the ring volume on the handset.

- **Key Tones** — controls whether pressing a key plays a tone.
- **Warning Tones** — controls whether warning tones are played when out-of-range or during power up and power down.
- **Display Contrast** — controls the amount of contrast for the display.
- **Keypad Autolock** — controls automatic locking of the keypad when the handset is in standby mode.

#### To select Noise Mode

1. While the handset is in standby mode, press the **Cfg** soft key.
2. Use the **Nav** keys to scroll through the menu and highlight **Phone Options**.
3. Press **Enter** to select the option. The next menu level is displayed.
4. Use the nav keys to scroll through the menu and select **Noise Mode**.
5. Press **Enter** to select the option.
6. Use the **Nav** keys to scroll through the menu and highlight one of the following settings (an asterisk [\*] indicates the selected setting):
  - **Normal:** For most office environments. This is the default setting.
  - **High:** For moderate background noise.
  - **Severe:** For extremely noisy conditions.

7. Press **Enter** to select the level.
8. Do one of the following:
  - Press **Back** to return to the previous menu and choose another option.
  - Press the **End** button to exit all menus and return to the standby state.

### To change the key tones

1. While the handset is in standby mode, press the **Cfg** soft key.
2. Use the **Nav** keys to scroll through the list of menu items and highlight **User Profiles**.
3. Press **Enter** to select the setting.
4. Use the **Nav** keys to scroll through the menu and highlight one of the following settings (an asterisk [\*] indicates the selected setting):
  - Enable Tones — This is the default.
  - Disable Tones
5. Press **Enter** to choose this setting.
6. Navigate to enable/disable key tones.
7. Press **Enter** to toggle between Enable/Disable.
8. Do one of the following:

Press **Back** to return to the previous menu and choose another option.

Press the **End** button to exit all menus and return to the standby state.

### To change the warning tones

1. While the handset is in standby mode, press the **Cfg** soft key.
2. Use the **Nav** keys to scroll through the menu and highlight **Phone Options**.
3. Press **Enter** to select the setting.
4. Use the **Nav** keys to scroll through the menu and highlight **Warning Tones**.
5. Press **Enter** to select the setting.
6. Use the **Nav** keys to scroll through the menu and highlight one of the following settings (an asterisk [\*] indicates the selected setting):
  - Enable Warnings — This is the default.
  - Disable Warnings
7. Press **Enter**.
8. Do one of the following:
  - Press **Back** to return to the previous menu and choose another option.
  - Press the **End** button to exit all menus and return to the standby state.

### To change the display contrast

1. While the handset is in the standby state, press the **Cfg** soft key.
2. Use the **Nav** keys to scroll through the menu and highlight **Phone Settings**.
3. Press **Enter** to select the menu item.
4. Use the **Nav** keys to scroll through the menu and highlight **Display Contrast**.
5. Press **Enter** to select the setting.

6. Use the **Nav** keys to adjust the contrast to a suitable level.
7. Press **Enter** to save the setting.
8. Do one of the following:
  - Press **Back** to return to the previous menu and choose another option.
  - Press the **End** button to exit all menus and return to the standby state.

### To change the keypad autolock

1. While the handset is in the standby mode, press the **Cfg** soft key.
2. Use the **Nav** keys to scroll through the menu and highlight **Phone Settings**.
3. Press **Enter** to select the setting.
4. Use the **Nav** keys to scroll through the menu and highlight **Keypad Autolock**.
5. Press **Enter** to select the setting.
6. Use the **Nav** keys to scroll through the menu and highlight one of the following settings (an asterisk [\*] indicates the selected setting):
  - Disable — this is the default.
  - 5 seconds
  - 10 seconds
  - 20 seconds
7. Press **Enter**.
8. Do one of the following:
  - Press **Back** to return to the previous menu and choose another option.

- Press the **End** button to exit all menus and return to the standby state.

## Viewing system information

---

The System Information option displays the following:

- Phone IP Address — displays the Internet Protocol (IP) address assigned to the handset.
- Server IP Address — displays the Server IP address.
- Firmware Version — displays the software version running on the handset.

**Note:** The information in the System Information option is for display purposes only. You cannot edit this information.

### To view the handset IP address

1. While the handset is in the standby state, press the **Cfg** soft key.
2. Use the **Nav** keys to scroll through the menu and highlight **System Information**.
3. Press **Enter** to select the setting.
4. Use the **Nav** keys to scroll through the menu and highlight **Phone IP Address**.
5. Press **Enter** to view the IP address.
6. Do one of the following:
  - Press **Back** to return to the previous menu and choose another option.
  - Press the **End** button to exit all menus and return to the standby state.

### To view the Server information

1. While the handset is in the standby state, press the **Cfg** soft key.
2. Use the **Nav** keys to scroll through the

menu and highlight **System Information**.

3. Press **Enter** to select the setting.
4. Use the **Nav** keys to scroll through the menu and highlight **Server IP Address**.
5. Press **Enter** to view the Server IP address.
6. Do one of the following:
  - Press **Back** to return to the previous menu and choose another option.
  - Press the **End** button to exit all menus and return to the standby state.

#### To view the Firmware information

1. While the handset is in the standby state, press the **Cfg** soft key.
2. Use the **Nav** keys to scroll through the menu and highlight **System Info**.
3. Press **Enter** to select the setting.
4. Use the **Nav** keys to scroll through the menu and highlight **FirmwareVersion**.
5. Press **Enter** to view the hardware identification number (MAC address), downloader version, function file version, and phint1 file version.
6. Do one of the following:
  - Press **Back** to return to the previous menu and choose another option.
  - Press the **End** button to exit all menus and return to the standby state.

## Entering Extension number

---

The Extension option enables the user to view the extension number for the handset. This number is used to identify the handset. It is displayed when the handset is in the standby state.

The Extension option is for display purposes. You cannot edit this option.

### To view the Extension

1. While the handset is in standby state, press the **Cfg** soft key.
2. Use the **Nav** keys to scroll through the menu and highlight **Extension**.
3. Press **Enter** to select the option.
4. Do one of the following:
  - Press **Exit** to return to the previous menu and choose another option.
  - Press the **End** button to exit all menus and return to the standby state.

## Setting up Push-to-talk

---

**Note:** The Push-to-talk feature is only available on the WLAN 6140 Handset.

Push-to-talk (PTT) mode enables two-way radio communication with another handset user. You can configure PTT by using the following:

- Channel — selects the channel to be used.
- Enable/Disable — enable or disable Push-to-talk.
- Audio Volume — set the audio volume when using Push-to-talk.
- Tone Volume — set the volume of the tone played for Push-to-talk.

### To set up a Push-to-talk channel

1. While the handset is in the standby state, press the **Cfg** soft key.
2. Use the **Nav** keys to scroll through the menu and highlight **Push-to-talk**.

3. Press **Enter** to select the option. The next menu level is displayed.
4. Use the **Nav** keys to scroll through the menu and highlight **Subscribed Channel**.
5. Press **Enter** to select the option.
6. Select a channel (one to eight).
7. Do one of the following:
  - Press **Done** to return to the previous menu and choose another option.
  - Press the **End** button to exit all menus and return to the standby state.

#### To enable or disable Push-to-talk

1. While the handset is in the standby state, press the **Cfg** soft key.
2. Use the **Nav** keys to scroll through the menu and highlight **User Profiles**.
3. Select the profile option. The next menu level is displayed.
4. Use the **Nav** keys to scroll through the menu and select **Enable/Disable Push-to-talk**.
5. Use the **Nav** keys to scroll through the menu and highlight one of the following settings (an asterisk indicates the selected setting):
  - PTT Enabled
  - PTT Disabled — default.
6. Press **Enter** to toggle between Enable/Disable.



7. Press **Enter** to select the setting.
8. Do one of the following:
  - Press **Back** to return to the previous menu and choose another option.
  - Press the **End** button to exit all menus and return to the standby state.

### To change the Push-to-talk audio volume

1. While the handset is in the standby state, press **Cfg** soft key.
2. Use the **Nav** keys to scroll through the menu and select **Push-to-talk**.
3. Press **Enter** to select the profile option. The next menu level is displayed.
4. Use the **Nav** keys to scroll through the menu and highlight **Push-to-talk Audio Volume**.
5. Press **Enter** to select the option.
6. Use the **Nav** keys to adjust the volume up or down.
7. Press **Enter** to select the setting.
8. Do one of the following:
  - Press **Back** to return to the previous menu and choose another option.
  - Press the **End** button to exit all menus and return to the standby state.

### To change the Push-to-talk tone volume

1. While the handset is in the standby state,

press **Cfg.**

2. Use the **Nav** keys to scroll through the menu and highlight **Push-to-talk**.
3. Press **Enter** to select the next menu level.
4. Use the **Nav** keys to scroll through the menu and highlight **Tone Volume**.
5. Press **Enter** to select the option.
6. Use the **Nav** keys to adjust the volume.
7. Press **Enter** to select the setting.
8. Do one of the following:
  - Press **Back** to return to the previous menu and choose another option.
  - Press the **End** button to exit all menus and return to the standby state.

## Call features

System administration is required for Call features. Contact your system administrator to ensure that these features are supported by the system software and to configure them on your handset.

### **ATTENTION!**

Access to the features and functions in the following sections are dependent on your system configuration. Contact your system administrator to determine whether specific features are accessible through your WLAN Handset 6120 and 6140.



# Making calls

This section describes the features associated with making a call.

## Use Autodial

---

The Autodial feature displays, stores, and automatically enters telephone numbers.

### To use Autodial:

1. While the handset is in standby mode, press the **Start** button.
2. To access the Feature Keys press the **Line** button.
3. To enter the number press a number (one through six) that corresponds with the DN.

### To display Autodial number:

1. While the handset is in standby mode, press the **End** button.
2. Press the **Line** button to view the first page of Autodial numbers.
3. Press the **Line** button again to view the next page of Autodial numbers.

### To store an Autodial number:

1. Press the **Line** button to access the Feature Keys menu.
2. Press a number (one through six) that corresponds to the desired location to store the number.
3. Enter the telephone number (including the access code) that you want to store on the selected **AutoDial** key.
4. Press the **Line** button again to access the Feature Keys menu.
5. Press the number key (one through six) that corresponds to the desired location selected in step 4 to store the number.

The selected line number flashes in the upper display area.

## Activate Ring Again

---

Use the **Ring Again (RngA)** feature if a busy tone sounds or when there is no answer after placing a call. **RngA** causes the ring again indicator to flash when the person you tried to call is available. **RngA** automatically reenters the number. The **RngA** soft key is available only when the handset is in the active state and you have selected the **More** soft key.

### To use Ring Again (RngA):

1. Press the **End** button.
2. Enter a number.
3. If you hear a busy tone or there is no answer, press the **RngA** soft key.

### To call a RngA party when you receive notification:

1. After you receive the visual notification, press **End**.
2. Press the **RngA** soft key to automatically call the number.

### To quit RngA before notification:

Before you see the visual notification, press the **RngA** soft key a second time.

## Redial last number called

---

The **Last Number Redial (Redl)** feature automatically redials the last dialed number.

### To use Last Number Redial (Redl):

1. Press the **End** button.
2. Press the **Actv** soft key.
3. Press the **Redl** soft key.
4. Scroll using the **Nav** keys to select the number that you wish to re-dial.

5. Press the **Dial** soft key.

## Use Speed Call

---

By entering a two-digit code (01–99), use the **Speed Call(Spdc)** feature to store, edit, and automatically enter frequently-called telephone numbers.

### To store a Speed Call (Spdc) number:

1. Press the **End** button.
2. Press the **Actv** soft key.
3. Press the **Spdc** soft key (one through six) corresponding to the **Speed Call Controller** feature.  
The triangular icon flashes indicating programming mode.
4. At the prompt, enter a two-digit code (01-99) and the telephone number. This number can be internal, external, or long distance.
5. Enter the access code, if required.

6. Press a number key (one through six) that corresponds to the **Speed Call Controller** feature again to save the code and number. The flashing icon turns off.

### To make a Speed Call:

1. Press the **End** button.
2. Select the **Actv** soft key.
3. Select the speed-dial number that you wish to call.

## Make a System Speed Call

---

Use the System Speed Call feature to enter Speed Call codes that override all restrictions on a call.

### To make a System Speed Call:

1. Press the **Start** button.
2. Press the **Spdc** soft key.
3. Select the system speed call number that you wish to call.



## Use Conference Hotline

---

Use the Conference Hotline feature to automatically enter a specific number. You can program other features such as Call Redirection to the Conference Hotline. Call Redirection redirects a Conference Hotline call so that it is answered only by one person.

### To use Conference Hotline:

1. Press **Start**.
2. To access the Feature Keys menu, press the **Line** button.
3. Press the number key (one through six) that corresponds to the **Conference Hotline** feature to automatically enter the number.



## While on an active call

This section describes the features that are available during an active call.

### Place a call on hold

---

Use the Hold feature when talking on one line and another call arrives on a second line. Retain the original call by placing it on hold and then answer the second call.

#### To place a call on hold:

To activate the **Hold** function, press **FCN** and select the **Hold** soft key. The number that corresponds to the line on hold flashes in the upper display area.

If **Automatic Hold** is enabled, the active call is automatically placed on hold when you answer the second call.

#### To retrieve a call on hold:

1. Press the **Line** button plus the line number of the call that you wish to retrieve to access the Feature Keys menu in the active (off-hook) state.
2. Press **Enter**.

### Transfer a call

---

Use the Transfer feature to redirect a call to the appropriate person.

#### To use the Transfer feature to direct a call to a third party:

1. Select the **Transfer** soft key.
2. Enter the seven-digit DN to which the call is being transferred.

**Note:** For more information on seven-digit Directory Numbers (DN), contact your system administrator.

3. When the number rings or a person answers, press the **Transfer** soft key again to talk.

## Use Attendant Recall

---

Use the Attendant Recall feature to contact an attendant during a call and to connect the call to the attendant.

**To contact the attendant while on a call:**

1. Press the **Line** button to access the Feature Keys menu.
2. Press the number key that corresponds to the **Attendant Recall** feature. Stay on the line until the attendant answers.
3. Press the **End** button. The caller remains connected to the attendant.

## Use Call Park

---

Use the Call Park feature to hold temporarily (park) and retrieve a call from any telephone or handset. Using Call Park does not tie up a line and, when configured network-wide, you can use it across networks. You can configure a **System Park Extension** to automatically park most calls.

### To park a call on the System Park DN or your own DN:

During an active call, select the **Park** soft key.

By default, the call is parked on your DN unless a **System Park** is enabled to automatically park calls on the system.

### To park a call on a DN other than the System Park DN or your own DN:

1. Select the **Park** soft key.
2. Enter the seven-digit DN where you want to park the call.

*Note:* For more information on seven-digit Directory Numbers (DN), contact your system administrator.

3. Select the **Park** soft key again.

### To retrieve a parked call:

1. Select a free extension.
2. Dial **SPRE** (Special Prefix) or **Call Park Access FFC** (Flexible Feature Code).
3. Dial the extension where the call is parked.

## Record a Calling Party Number

---

Use the Calling Party Number feature to record a caller's number or to charge a call to an account number for accounting purposes during an established call.

To record a caller's number for accounting purposes:

1. Press the **Call Party** soft key to place the caller on hold. The entered number displays.
2. Enter a charge account number or the caller's number.
3. Press the **Call Party** soft key to return to the call.

## Display incoming calls

---

Use the Display feature to display a second incoming caller's number and name (if available) during an active call, without interfering with the call in progress.

To view the information on an incoming call while on a call in progress:

1. Press the **Line** button to access the Feature Keys menu.
2. Press the number that corresponds to the **Display** feature to activate the feature.
3. Press the **Line** button to access the Feature Keys menu.
4. Press the number key that corresponds to the flashing line. The call waiting information displays.

## Trace a malicious call

---

Use the Malicious Call Trace feature to trace nuisance calls within your system.

To use Call Trace while on a call:

1. Press the **Line** button to access the Feature Keys menu.
2. Press the number key that corresponds to the **Call Trace** feature.

## Using Record On Demand key

---

If this feature is enabled, you can use the Record on Demand (ROD) feature key to record your telephone conversation.

Press the ROD key to start or stop the call recording. This key is associated with the active user ID and is displayed only if a call is active. The ROD key blinks while it is connecting to the call recording application, and is lit when the call is recording.

The ROD key is displayed in the following scenarios:

- Normal operation - Press the ROD key during an active call to record the call.
- Call Recording (CR) application in ROD Mode - Press the ROD key during an active call to record the call
- Bulk Recording - For an active call or unregistered DN/Position ID, call recording is initiated even though the ROD key is not pressed..

1. Press the **ROD** key during an active call.
2. To stop the call recording, press the **ROD** key again.

## Using SAVE key

---

Use the **SAVE** feature key to save the recording of an active call. This key is associated with the active user ID and is operational only if a call is active.

The **SAVE** key is displayed in the following scenarios:

- Normal operations - If the **SAVE** key is pressed during an active call, the call is saved.
- CR application in Bulk Record + Save everything mode - Recorded conversation is saved at the end of the call. If the **SAVE** key is pressed, then the call is not saved.
- CR application in Bulk Record + Delete everything mode - Recorded conversation is deleted at the end of the call. If the **SAVE** key is pressed, then the call is saved.

The **SAVE** key lamp status depends on the status of the call recording. If the call is to

be saved, then the lamp is lit..

1. Press the **ROD** key during an active call.
2. To stop the call recording, press the **ROD** key again.
3. Press the **SAVE** key to save the conversation.



# Incoming calls

This section describes the features that are available to you when a call is incoming.

## Activate Call Pickup

---

Use the Call Pickup feature to pick up calls from any telephone or handset in the same pickup group or in another pickup group.

### To answer a call in your own Call Pickup group:

1. Press the **Start** button.
2. Press **Pickup**.

### To answer an incoming call in another Call Pickup group:

1. Press the **Start** button.
2. Press the **Line** button to access the Feature Keys menu.
3. Press the number key that corresponds to the **Group Pickup** feature.
4. Enter the pickup group number of the ringing handset.

### To answer a call at a specific extension in any pickup group:

1. Press the **End** button.
2. Press the **Line** button to access the Feature Keys menu.
3. Press the number key that corresponds to the **Pickup** feature.

4. Enter the DN of the handset that is ringing (in your call pickup group).

If the pickup DN or group number is invalid, press the **End** button.

## Use Call Waiting

---

The Call Waiting feature alerts you to an incoming call by producing a tone. It also puts the current call on hold while you answer the new call.

### To answer an incoming call while on another call:

1. When the incoming call tone sounds, press **FCN** to display the Hold soft key. Press the Hold soft key to place the current call on hold.

If **Automatic Hold** is enabled, it is not necessary to put the current call on hold. Begin with step two.

2. Press the **Line** button to access the Feature Keys menu.
3. Press the number key that corresponds to the **Call Waiting** feature.

### To return to the first telephone call:

1. Choose one of the following:
  - Select **FCN** to display the Hold soft key. Press the Hold soft key to place the current call on hold and return to the first call.

or

  - Press the **End** button to end the second call and then press the **Start** button to enter the active (idle) state.

2. Press the **Line** button to access the Feature Keys menu.
3. Press the number key that corresponds to the first call.

The first call that is on hold flashes so the number indicator for that line flashes.



## While away from your desk

This section describes features that are used when you are away from your desk.

### Use Call Forward

---

Use the Call Forward feature to direct incoming calls to ring at another Line (DN).

**Note:** If the handset is in the process of ringing, that call cannot be forwarded.

**To forward your calls or change the forward number:**

1. Press the **End** button.
2. Place the handset in the active (idle) state by pressing the **Actv** soft key.
3. Press **Fwrld**.
4. Enter the seven-digit DN where you want to forward your calls.

**Note:** For more information on seven-digit Directory Numbers (DN), contact your system administrator.

5. Press **Fwrld** a second time.
6. Press the **End** button to turn off the handset.

**To quit Call Forward:**

Press **Fwrld**.

**To reinstate Call Forward to the same number:**

Press **Fwrld** twice.

## Use Internal Call Forward

---

Use Internal Call Forward to accept only calls that originate at internal DNs to ring at another DN. Calls that originate outside your telephone system still ring at your handset. Current incoming calls cannot be forwarded.

### To forward internal calls:

1. Press the **Line** button to access the Feature Keys menu.
2. Press the number key that correspond to the **Internal Call Forward** feature.
3. Enter the seven-digit DN to which your internal calls are to be forwarded.

*Note:* For more information on seven-digit Directory Numbers (DN), contact your system administrator.

4. Press the **Line** button to access the Feature Keys menu.
5. Press the number key that corresponds to the **Internal Call Forward** feature.

### To quit Internal Call Forward:

1. Press the **Line** button to access the Feature Keys menu.
2. Press the number key that corresponds to the **Internal Call Forward** feature.

### To reinstate Call Forward to the same number:

1. Press the **Line** button to access the Feature Keys menu.
2. Press the number key that corresponds to the **Internal Call Forward** feature twice.

## Talk with more than one person

This section describes the features that you can use to hold conversations among more than two people.

### Use Call Join

---

Use the Call Join feature to connect calls to the current active call. This feature creates a conference between two callers and yourself.

**To connect a call on hold (on a different line) to your current call:**

1. Press the **Conference** soft key.
2. Press the **Line** button to access the Feature Keys menu.
3. Press the number key that corresponds to the number of the caller that you want to connect to your current call.
4. Press the **Conference** soft key a second time to add the person on hold to your conversation.

### Set up a conference call

---

Use the Conference feature to set up a conference call for three people (or six people, depending on your handset configuration), including yourself.

**To set up a conference call:**

1. While on a call, press the **Conference** soft key to place the party on hold. You hear a dial tone.
2. Enter the number of the person you want to add to the conference call. Before you add this person to the call, you can talk privately to them.
3. Press the **Conference** soft key a second time to add all the parties to the call.

4. If necessary, repeat the procedure until all the required people are in the conference.

**If the person you attempt to add to the conference is unavailable:**

1. Press the **End** button.
2. Press the **Line** button to access the Feature Keys menu.
3. Press the number key that corresponds to the flashing line icon to return to your original call.

## **Use Conferee Selectable Display**

---

Use the Conferee Selectable Display feature to list active conferees and to disconnect a conferee from the conference call.

**To view active conferees:**

1. While on a conference call, press the **Line** button to access the Feature Keys menu.
2. Press the number key that corresponds to the **Conferee Selectable Display** feature to turn on the LCD indicator. Each key press changes the screen to show a different active conferee.

This action has no effect on the display of other telephones that are involved in the conference.



3. Press the **End** button. If configured, the **Conference Count Display** returns an updated total count of conferees. The LCD indicator turns off.

#### To disconnect a conferee:

1. While on a conference call, press the **Line** button to access the Feature Keys menu.
2. Press the number key that corresponds to the **Conferee Selectable Display** feature until the conferee that you want to disconnect appears on the screen.
3. Press the number key that corresponds to the line on which the conference call is established.
4. Choose one of the following:
  - For a single conferee, press the **End** button. If configured, the **Conference Count Display** returns an updated total count of conferees. The LCD indicator turns off.
  - For multiple conferees, repeat steps one, two and three until all the conferees are disconnected.
5. Press the **End** button.

## Use Group Call

---

Use the Group Call feature to automatically call members of a predefined group, one at a time, until they all answer.

#### To call group members:

1. Press the **End** button.
2. Press the **Line** button to access the Feature Keys menu.
3. Press the number key that corresponds

to the **Group Call** feature.

The feature automatically calls all group members. The icon flashes until all members answer.

The line numbers of the group members appear on the display as they answer. When the last participant answers, the **Group Call** indicator lights steadily.

When a party in your group is on a conference call or another group call, they are not connected to your group call.

After everyone in the group answers, only the party who made the group call can put the call on hold.

**To answer a group call:**

Press the **End** button.

**About Notification tones:**

- If you are on a call and receive three 10-second tones, this is the notification of a group call on your current extension.
- If you are on a call on another line on your handset when a group call is made, you receive a long tone through the handset or speaker.
- You do not receive a notification of a group call if you are already on a conference call or another group call.

**To end a group call:**

Press the **End** button..

When the party who made the group call disconnects, the call terminates for all members of the group. However, the other members of the group call can disconnect from the call and not affect the members still on the call.



## Work without interruption

This section describes the features that provide uninterrupted work time.

### Activate Make Set Busy

---

Use the Make Set Busy feature to make your handset appear busy to all callers.

#### To activate Make Set Busy:

1. With the handset in standby mode, press the **Line** button to access the Feature Keys menu.
2. Scroll using the **Nav** keys and highlight the **Make Set Busy** feature.
3. Select **Enter**.

#### To deactivate Make Set Busy:

1. With the handset in standby mode, press the **Line** button to access the Feature Keys menu.
2. Scroll using the **Nav** keys and highlight the **Make Set Busy** feature a second time.
3. Select **Enter**.

### Call Deflect

---

Use the Make Set Busy feature to make your handset appear busy to all callers.

If Call Deflect is configured on your WLAN Handset 6120/6140, you can press the press the Line key to access your Feature keys, and then press the Deflect feature key to deflect your call if your WLAN Handset 6120/6140 rings and you do not want to answer the call. The call may be forwarded to your voice mail or to another telephone number, depending on your system configuration. Contact your system administrator to learn which treatment is configured for your WLAN Handset 6120/6140

1. If you press the **Deflect** key and no special call treatment has been configured, your caller receives a busy signal.

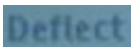



## Other call features

This section describes some of the call features available on your WLAN Handsets 6120 and 6140.

### Use Call Page Connect to make an announcement

---

Use the Call Page Connect feature to make an announcement over a paging system.

**Note:** A **Page** key on an attendant console overrides and disconnects the telephones. The telephones must reaccess the Page trunk.

#### To connect to Call Page:

1. While the handset is in active mode, enter the **Page Trunk Access Code** to complete the connection to the page system.
2. Make your announcement.
3. Press the **End** button.

#### To disconnect Call Page:

### Use Centrex/Exchange Switchhook Flash

---

Use the Centrex/Exchange Switchhook Flash feature during an established call to use a Centrex service, such as Call Transfer or Three-Way Calling.

#### To use Centrex/Exchange Line Switchhook Flash:

1. While in a call, press the **Line** button to access the Feature Keys menu.
2. Press the number that corresponds to the **Centrex Switchhook Flash** feature.  
A special dial tone sounds.
3. Enter the codes for your custom **Centrex** feature.
4. Press the **End** button.

## Charge a call or charge a forced call

---

Use the Call Charge feature to charge a call to a specific account. The Forced Charge feature charges long-distance calls from a handset that is restricted to local calls.

### To charge a local or long-distance call to an account before you dial:

1. Select **More**.
2. Select the **Charge** soft key.
3. Enter the charge account number.
4. Press the **Charge** soft key again.
5. At the tone, dial the number.

### To charge a call in progress:

1. Select the **Transfer** soft key or the **Conference** soft key. The call is placed on hold.
2. Press the **Charge** soft key.
3. Enter the charge account number.
4. Press the **Line** button to access the Feature Keys menu.
5. Press the number key that corresponds to the line of the call to return to the call.



**To charge a call to an account when you transfer a call:**

1. Place the call on hold by pressing FCN and then pressing **Hold**.
2. Press the **More** soft key until the **Charge** soft key is displayed.
3. Press the **Charge** soft key.
4. Enter the charge account number.
5. After you hear the dial tone, enter the number to which the call is to be transferred.
6. Press the **Transfer** soft key when you hear the handset ring.

You can talk privately to the person at the transfer number before you press the **Transfer** soft key.

**To charge a call to an account when you add someone to a conference call:**

1. Place the call on hold by pressing FCN and then pressing **Hold**.
2. Press the **More** soft key until the **Charge** soft key is displayed.
3. Press the **Charge** soft key.
4. Enter the charge account number.
5. Enter the number of the person that you want to add to the conference.
6. Select the **Conference** soft key.

## Use Enhanced Override

---

Use the Enhanced Override feature to override an active call after you attempt to use a Forced Camp-on. Use Enhanced Override to make a simple call or a consultation call (such as placing a call on hold and calling another party).

### To use Enhanced Override:

1. If you receive a busy signal after entering a number, press the **Line** button to access the Feature Keys menu.
2. Press the number key that corresponds to the **Override** feature to initiate a Forced Camp-on.

If either party on the call disconnects at this time, you hear an overflow (fast busy/engaged) signal.

3. Press the number key that corresponds to the **Override** feature again.

The two parties remaining on the call hear an override tone, and a conference call is established between all three participants. If a participant disconnects, the other two remain connected.

### To end the connection:

Press the **End** button.

## Use Forced Camp-on

---

Use the Forced Camp-on feature to automatically ring another handset (internal or external) immediately after that handset disconnects from its current call. Using Forced Camp-on in conjunction with Priority Override is referred to as Enhanced Override.

### To use Forced Camp-on:

1. If you receive a busy signal after entering a number, press the **Line** button to access the Feature Keys menu.

2. Press the number key that corresponds to the **Override** feature to initiate a Forced Camp-on.

The party that you called receives a tone, and you receive a ring/ringback signal or busy/engaged signal, depending on the options chosen. You are now camped-on to the number you entered.

3. When the party that you called finishes their call, your handset automatically enters the number. Both your handset and their handset rings.

When the handset rings, press the **Start** button.

You can program your handset for either Camp-on or Call Waiting, but not both.

**To answer a call camped on to your extension:**

## Use Privacy Release

---

Use the Privacy Release feature to enable one or more people who share your DN to join a call.

**To use Privacy Release:**

1. Press the **Line** button.
2. Press the **Privacy Release** soft key during a call. A party joins the call by pressing the shared number (DN) key on their handset (Multiple Appearance DN feature).



## Branch Office

This section describes the Branch Office handset which can operate in Normal Mode or Local Mode.

### Normal Mode

---

In Normal Mode, the handset registers with the Main Office and receives services from the Main Office. At any time during Normal Mode, you can check local mode functionality (make and receive calls) by enabling Local Mode and then return to Normal Mode.

### Local Mode

---

If the WAN connection goes down, the handset loses communication with the Main Office TPS. The handset then registers with the Branch Office and receives services from the Branch Office. When in Local Mode, **Local Mode** displays on the handset.

### Troubleshoot Branch Office

---

When using Branch Office, you can see error messages on your screen. Table 4 lists error messages and corrective actions.

**Table 4**  
**Troubleshoot Branch Office**

Display Message	Probable Cause	Actions
Local Mode	Network problem.	Contact local network administrator if problem persists.
Local Mode Invalid ID (1)	Gatekeeper unable to find end point from Branch User ID.	Notify local network administrator.
Local Mode Invalid ID (2)	Branch User ID not found in any equipped TN.	Notify local network administrator.



# Hospitality features

The hospitality features in this section are intended for hotel operations.

## Activate Message Registration

---

Use the Message Registration feature to read, change, or reset meters that log your hotel calls.

### To read meters:

1. Press the **Line** button to access the Feature Keys menu.
2. Press the number key that corresponds to the **Message Registration** feature.
3. Enter the room Directory Number (DN).
4. Press the number key that corresponds to the **Message Registration** feature again.

### To change a meter:

1. Press the **Line** button to access the Feature Keys menu.
2. Press the number key that corresponds to the **Message Registration** feature.
3. Enter the room DN number.
4. Enter the correct meter count.
5. Press the \* key.
6. Press the **Line** button to access the Feature Keys menu.
7. Press the number key that corresponds to the **Message Registration** feature again.

### To reset a meter to zero:

1. Press the **Line** button to access the Feature Keys menu.
2. Press the number key that corresponds

to the **Message Registration** feature.

3. Enter the room Directory Number (DN).
4. Press the \* key.
5. Press the **Line** button to access the Feature **Keys** menu.
6. Press the number key that corresponds to the **Message Registration** feature again.

## Use Maid Identification

---

Use the Maid Identification feature to track the cleaning status of rooms. The maid enters the information from the telephone in each room.

### To enter cleaning status:

1. Press the **Line** button to access the Feature Keys menu.
2. Press the number key that corresponds to the **Room Status** feature.
3. Enter the Directory Number (DN) for the room for which the cleaning status is being changed.
4. Enter one of the following cleaning status codes:
  - 1 = Cleaning requested
  - 2 = Cleaning in progress
  - 3 = Room cleaned
  - 4 = Room passed inspection
  - 5 = Room failed inspection
  - 6 = Cleaning skipped
  - 7 = Not for sale

The interrupted dial tone sounds.

5. Press the \* key.
6. Enter the **Maid** ID. If you enter the



wrong **Maid** ID, press the \* key and redial the ID.

7. Press the **Line** button to access the Feature Keys menu.
8. Press the number key that corresponds to the **Room Status** feature.

## Display Room Status

---

The Room Status feature prints the status of a room by using the Display Module.

### To read the status of a room:

1. Press the **Line** button to access the Feature Keys menu.
2. Press the number key that corresponds to the **Room Status** feature.
3. Enter the Directory Number (DN) for the room. The DN displays followed by a two-digit code.

The first digit indicates the occupancy status:

0 = Room vacant

1 = Room occupied

The second digit indicates the cleaning status of the room:

1 = Cleaning requested

2 = Cleaning in progress

3 = Room cleaned

4 = Room passed inspection

5 = Room failed inspection

6 = Cleaning skipped

7 = Not for sale

4. Press the **Line** button to access the Feature Keys menu.

5. Press the number that corresponds to the **Room Status** feature.

### To change the status of a room:

1. Press the **Line** button to access the Feature Keys.
2. Press the number key that corresponds to the **Room Status** feature.
3. Enter the Directory Number (DN) for the room. The DN displays followed by a two-digit code.

The first digit indicates the occupancy status:

0 = Room vacant

1 = Room occupied

The next digit indicates the cleaning status of the room:

1 = Cleaning requested

2 = Cleaning in progress

3 = Room cleaned

4 = Room passed inspection

5 = Room failed inspection

6 = Cleaning skipped

7 = Not for sale

4. Enter the status code for the room. A three-digit code appears. The first digit indicates the occupancy status, the second the old cleaning status, and the third the new status.
5. Press the **Line** button to access the Feature Keys menu.
6. Press the number key that corresponds to the **Room Status** feature.

## Battery packs

This section provides information on the battery packs for the WLAN Handset 6120 and 6140.

The interchangeable Lithium Ion battery for the WLAN Handset 6120 and 6140 must be recharged periodically.

- Standard Battery Pack capacity:
  - for moderate call usage
  - requires up to two hours to fully charge
- Extended Battery Pack capacity:
  - for intermediate call usage
  - requires up to three hours to fully charge
- Ultra-Extended Battery Pack capacity:
  - for heavy call usage
  - requires up to four hours to fully charge

Recommended battery replacement interval is every 12 - 13 months under normal usage duty cycle.

Batteries deteriorate continuously at various rates from the time they are manufactured. Storage temperature is an important deterioration factor for all types of batteries. The cooler a battery is kept, the slower it will deteriorate, as long as its temperature remains above freezing. Damaging changes can occur in some types of batteries below freezing, so generally batteries should not be stored in a freezer or otherwise in freezing temperatures.

### Low battery indicators

---

The Battery Pack icon on the status line of the handset display provides a visual indication of the amount of charge that remains in the Battery Pack. When the icon shows empty, if the handset is in standby mode, you hear a brief, modulated-ring signal, and the Battery Low message appears. The handset cannot be used until it is charged. If you are in a call and the battery is low, you hear soft beeps, first slow and then fast, until the handset is unusable. When you first hear the beeps, you have two minutes to end the call before the handset becomes unusable.

## Removing and inserting the battery pack

---

### To remove a battery pack

1. Press down on the latch on the battery pack at the back of the handset.
2. Pull the battery pack towards you.  
The battery pack releases outward.

### To insert a battery pack

1. Slide the lip of the battery pack into the handset cavity.
2. Push the top of the battery pack until it snaps into place.

Do not force the battery pack into the handset.

## Charging your handset

---

### To charge a battery pack

You must charge the battery pack before its first use.

1. Press **End** to terminate any calls.  
The handset can be off or in standby state during charging.
2. Place the handset, face forward, into the Desktop Charger.

An animated charge icon indicates that charging is in progress.

3. Charge the battery pack.

If the handset is in standby mode, it displays its extension number and **Charging**. It is fully operational and can receive calls. If the handset is off, only **Charging** is displayed and the handset cannot receive calls.

It is normal for the battery pack to become warm when charging.

4. When the handset is fully charged, **Charge Complete** is displayed. Remove the handset from the charger.

## Desktop Chargers

Three charger models are available for the WLAN Handset 6120 and 6140.

- Single Charger — Charges one handset with an installed battery pack.
- Dual Charger — Charges the handset and a spare battery pack.
- Quad Charger — Charges up to four battery packs at one time.

### Single Charger

---

The single charger is designed so that the handset can remain operational through speakerphone or headset use while the battery pack is being charged. The handset can also be charged while in standby mode or powered off mode.

**Figure 5**  
The WLAN Handset 6120 and 6140 Desktop Charger



#### **ATTENTION**

Do not place anything in the Desktop Charger other than the WLAN Handset 6120 and 6140. Because you might damage the contacts. Bent contacts can stop the charging of the handset.

## Using the Single desktop charger

---

To charge the WLAN Handset 6120 and 6140

1. Press **End** to terminate any calls.  
The handset can be off or in standby state during charging.
2. Place the handset, face forward, into the Desktop Charger.

An animated charge icon indicates that charging is in progress.

3. Charge the battery pack.

If the handset is in standby mode, it displays its extension number and **Charging**. It is fully operational and can receive calls. If the handset is off, only **Charging** is displayed and the handset cannot receive calls.

It is normal for the battery pack to become warm when charging.

4. When the handset is fully charged, **Charge Complete** is displayed. Remove the handset from the charger.

## Cleaning the Desktop Charger

---

Clean the Desktop Charger by wiping the surface with a plain-water-dampened cloth or paper towel. A mild detergent solution can be used. Be sure to wipe away any detergent residue with a plain-water-dampened cloth.



### CAUTION

- Do not immerse the charger in water or any other liquid.
- Do not pour liquids into the charger slot.

You can clean the battery pack contacts on the handset with isopropyl (rubbing) alcohol applied with a cotton swab, cloth, or paper towel. Do not push or pull the

exposed battery pack contacts.

### **ATTENTION**

- Always use the Desktop Charger provided to charge the battery pack. Other chargers can damage the battery pack.
- Only use the original plug-in power adapter for the Desktop Charger.
- Do not dip the battery pack in water or throw into a fire.
- Do not dispose of the battery pack with your domestic waste. Take used battery packs to an appropriate collection point for recycling or send them back to your supplier or servicing agent.
- Replacement battery packs are available from your supplier or servicing agent.



## Dual Charger

This section describes the dual charger available with the WLAN Handset 6120 and 6140.

The Dual Charger for the WLAN Handset 6120 and 6140 charges the battery pack in the handset while it remains operational and also charges an additional battery pack in the rear charging bay.

**Figure 6**  
**The WLAN Handset 6120 and 6140 Dual Charger**

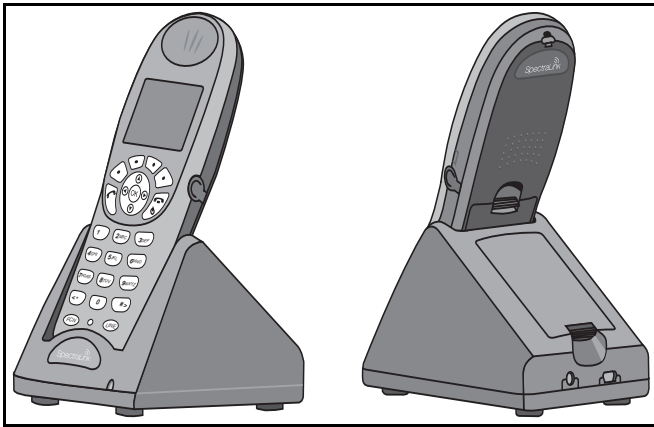

The Dual Charger comes with the appropriate power supply for the site. Place the Dual Charger on a flat, horizontal surface. Plug the power supply into the Dual Charger and into an appropriate wall outlet.

### **ATTENTION**

Do not place anything in the Dual Charger other than the WLAN Handset 6120 and 6140 battery packs because you can damage the contacts. Bent contacts can stop the charging of the battery packs.

The handset and spare battery cannot charge simultaneously. If both require charging, the handset has priority and recharges first. After the handset is fully charged, the spare battery is charged.

### Using the Dual Charger

---

To charge the WLAN Handset 6120 and 6140

1. Place the handset, face forward, into the front slot of the Dual Charger.

The handset can be off or in standby mode during charging. The LED displays the charging status. See instruction Single charger.

2. Charge the handset battery.

If the handset is in standby mode, it displays its extension number and **Charging**. It is fully operational and can receive calls. If the handset is off, only **Charging** is displayed and the handset cannot receive calls.

It is normal for the battery pack to become warm when charging.

3. When the handset is fully charged, **Charge Complete** is displayed. Remove the handset from the charger.

The battery pack starts to charge.

The LED indicates the status of the Battery Pack in the rear bay. The handset displays its charging status as described for the Single Charger. When the handset is fully charged or is removed, the Battery Pack begins charging.

*Note:* It takes longer for the Battery Pack to charge if you place a handset in the front slot.

### Cleaning the Dual Charger

---

Clean the Dual Charger by wiping the surface with a plain-water-dampened cloth or paper towel. A mild detergent solution can be used. Be sure to wipe away any detergent residue with a plain-water-dampened cloth.

**CAUTION**

Do not immerse the charger in water or other liquid.

Do not pour liquids into the charger slot.

You can clean the battery pack contacts on the handset with isopropyl (rubbing) alcohol applied with a cotton swab, cloth, or paper towel. Do not push or pull the exposed battery pack contacts.

**IMPORTANT**

- Always use the Desktop Charger provided to charge the battery pack. Other chargers can damage the battery pack.
- Only use the original plug-in power adapter for the Desktop Charger.
- Do not dip the battery pack in water or throw into a fire.
- Do not dispose of the battery pack with your domestic waste. Take used battery packs to an appropriate collection point for recycling or send them back to your supplier or servicing agent.
- Replacement battery packs are available from your supplier or servicing agent.

## Quad Charger

This section describes the quad charger that is available with the WLAN Handset 6120 and 6140.

The quad charger is designed so that the handset can remain operational through speakerphone or headset use while the battery pack is being charged. The Nortel WLAN Handset 6120 and 6140 Quad Charger (see Figure 7) can simultaneously charge four battery packs. You can mount the quad charger on either a horizontal or a vertical surface. The battery pack snaps into the charging slot. The indicator light above the occupied bay indicates the charging status of the battery pack in the bay.

**Figure 7**  
**The WLAN Handset 6120 and 6140 Quad Charger**

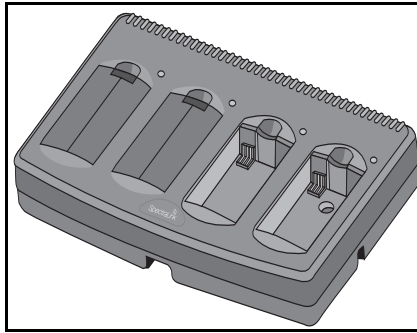

The Quad Charger includes the appropriate power supply for the site. Place the Quad Charger on a flat, horizontal surface. Plug the power supply into the Quad Charger and into an appropriate wall outlet.

### **IMPORTANT**

Do not place anything in the Quad Charger other than the WLAN Handset 6120 and 6140 battery packs. You might damage the contacts. Bent contacts can keep the battery packs from charging.

## Using the Quad Charger

---

### **To charge a battery pack**

1. Insert the battery pack into one of the four charging bays.

The LED above the charging bay turns on. If the LED starts to blink as soon as

the battery pack is inserted, remove the battery pack and reinsert it into the charger.

If a flashing LED indicates a battery pack failure, check the battery pack in a different bay or substitute another charger and repeat the operation that caused the failure. If the same battery pack lights a steady LED when inserted in a different bay or charger, the first charger can be faulty. Contact your system administrator for service information.

2. When charging is complete, the LED turns off. Remove the battery pack from the charger.

## Cleaning the Quad Charger

---

Clean the Quad Charger by wiping the surface with a plain-water-dampened cloth or paper towel. A mild detergent solution can be used. Be sure to wipe away any detergent residue with a plain-water-dampened cloth.



### CAUTION

- Do not immerse the charger in water or any other liquid.
- Do not pour liquids into the charger slot.

You can clean the battery pack contacts on the handset with isopropyl (rubbing) alcohol applied with a cotton swab, cloth, or paper towel. Do not push or pull the

exposed battery pack contacts.

### **IMPORTANT**

- Always use the Quad Charger provided to charge the battery pack. Other chargers can damage the battery pack.
- Only use the original plug-in power adapter for the Quad Charger.
- Do not dip the battery pack in water or throw into a fire.
- Do not dispose of the battery pack with your domestic waste. Take used battery packs to an appropriate collection point for recycling or send them back to your supplier or servicing agent.
- Replacement battery packs are available from your supplier or servicing agent.

## Terms you should know

### Attendant

A telephone operator in your organization.

### Autodial

A telephone number programmed on the Autodial key for one-touch dialing.

### Call party information

The display showing Call Party Name Display (CPND) information including the telephone number and name of the incoming call. The system must have CPND enabled.

### Desktop Charger

The Desktop Charger is used to recharge the battery pack for the WLAN Handset 6120 and 6140 and a spare battery pack.

### DNS

Domain Name System (DNS), an industry-standard protocol, locates computers on an IP-based network.

### Directory Number (DN)

A number consisting of one to seven digits for a handset. This number is also known as an *extension number*.

### Dual Charger

The Dual Charger is used to recharge the battery pack for the WLAN Handset 6120 and 6140

### Feature display

An area that shows status information about the feature in use. It also displays the name and status of the active session.

### Feature keys

The features that are accessed by pressing the Line key.

### **Fixed key**

The hard-labeled keys on your handset..

### **Indicator**

An LCD or an LED that indicates the status of a feature by a flash, wink, steady on, or off.

### **Interrupted dial tone**

A broken or pulsed dial tone, heard when you access some of the features on your handset.

### **More**

An option that enables access to the multiple layers of the soft key features. These keys are the four keys located directly below the display area.

### **Paging tone**

A special tone that is heard when you use the Radio Paging feature. You hear two beeps followed by dial tone.

### **Primary Directory Number**

The main extension number on your handset. It is also called the Primary Directory Number (PDN) key.

### **Private Line**

You can assign the Private Line feature to your handset. With this line, you can reach an outside number without dialing a code to access an outside line. Internal extensions cannot be dialed from a private line.

### **Quad Charger**

The Quad Charger is used to recharge up to four battery packs at one time for the WLAN Handset 6120 and 6140.

### **Real-Time Location System (RTLS)**

The Real-Time Location System (RTLS), a position and tracking tool, is a fully automated system that continually monitors the location of assets and personnel.



**Secondary Directory Number**

A second incoming/outgoing line for your handset.

**Shared Directory Number**

A DN (extension) that is shared by two or more persons.

**Soft keys (self-labeled)**

A set of keys programmed by your system administrator. These four keys located directly below the display area have four programmable layers. The layers are accessed through the **More** soft key.

**Special dial tone**

The three consecutive tones followed by a dial tone that you hear when you access handset features.

**Status Messages**

A message displayed to inform the user of important information. A right arrow appears if more than one Status Message is present. Examples of Status Messages include: Message Waiting; All Lines Forwarded to: 6453; Do Not Disturb On; Ring Again active; Ringer is OFF; and Line x Unavailable.

**System or switch**

Your office communications system.

**TFTP**

TFTP is used to update the WLAN Handset software over the wireless LAN.

**User Interface**

In this User Guide, *User Interface* refers to the display screen that interacts with the end user as a result of an action or event.



# Index

---

## A

Active (off-hook) state 25  
Attendant 117  
Attendant Recall 76  
Auto Dial 117  
Autodial 69

## B

Battery packs 105  
Branch Office 99

## C

Call Forward 83  
Call Join 85  
Call Page Connect 93  
Call Park 77  
Call Party 77  
Call party information 117  
Call Pickup 79  
Call Trace, Malicious 78  
Call Waiting 80  
Centrex/Exchange Switchhook Flash 93  
Charge a call 94  
Charge a Forced call 94  
Charge the battery pack 112, 114  
Charge the Wireless Handset 109, 112  
Clean the Desktop Charger 109  
Clean the Dual Charger 112  
Clean the Quad Charger 115

Clean the Wireless Handset 29  
Conferee Selectable Display 86  
Conference call 85  
Conference Hotline 73

## D

Desktop Charger 108, 109, 117  
Directory Number 117  
Display incoming calls 78  
DN 117  
Dual Charger 111, 112, 117

## E

Enhanced Override 95  
Extension 62

## F

Feature display 117  
Feature Keys 118  
Fixed key 118  
Flexible Feature Code (FFC) 118  
Forced Camp-on 96  
Function key 23

## G

Group Call 87

## H

High Noise Mode 56  
Hold a call 75  
Hospitality features 101

**I**

Indicator status 118  
Insert the battery pack 106  
Internal Call Forward 84  
Interrupted dial tone 118

**L**

Last Number Redial 70  
Line key 22  
Local mode 99  
Lock the keypad 50  
Low battery indicators 105

**M**

Maid Identification 102  
Make Set Busy 91  
Message Registration 101  
More Key 118

**N**

Normal mode 99

**O**

Override a busy signal 97

**P**

Paging tone 118  
Power Off/End Call key 22  
Power On/Start Call key 22, 25  
Primary Directory Number 118  
Privacy Release 97  
Private Line 118  
Push-to-Talk 38, 63

**Q**

Quad Charger 114, 118

**R**

Record a Caller's Number 77  
Redial last number called 70  
Remove the battery pack 106  
Ring Again 70  
Ring Type 51  
Room Status 103

**S**

Secondary Directory Number 119  
Security 46  
Shared Directory Numbers 119  
Soft key 23  
Soft keys 119  
speakerphone 24  
Special dial tone 119  
Speed Call 71  
    System 72  
Standby state 25  
Standby time 105  
Status Messages 119  
System or switch 119  
System Speed Call 72

**T**

Transfer a call 75  
Troubleshoot Branch Office 99

**U**

Up, Down, and Select buttons 23

User Interface 119

User Option menu 50, 51, 56, 61, 62, 63

## **V**

Volume

Ring 42





Nortel Communication Server 1000

# **Nortel WLAN Handset 6120 and WLAN Handset 6140**

## **User Guide**

Copyright © 2007-2010 Nortel Networks. All Rights Reserved.

### LEGAL NOTICE

While the information in this document is believed to be accurate and reliable, except as otherwise expressly agreed to in writing NORTEL PROVIDES THIS DOCUMENT “AS IS” WITHOUT WARRANTY OR CONDITION OF ANY KIND, EITHER EXPRESS OR IMPLIED. The information and/or products described in this document are subject to change without notice.

Nortel, the Nortel logo and the Globemark are trademarks of Nortel Networks.

All other trademarks are the property of their respective owners.

Publication Number: NN43150-100

Document Release: Standard 04.01

Date: June 2010

Sourced in Canada

To provide feedback or report a problem in this document, go to  
<http://www.nortel.com/documentfeedback>



[www.nortel.com](http://www.nortel.com)