

Documentation

OpenScope Voice

OpenStage 40 SIP, OpenStage 40 G SIP

OpenStage Key Module 40

User Guide





Communication for the open minded



Siemens Enterprise Communications
www.siemens-enterprise.com

SIEMENS

Important information

	<p>For safety reasons, the telephone should only be supplied with power:</p> <ul style="list-style-type: none">• using the original power supply unit. Part number: L30250-F600-C14x (x: 1=EU, 2=US, 3=UK) or• in a LAN with PoE (Power over Ethernet), which complies with the IEEE 802.3af standard.
	<p>Use only original Siemens accessories. The use of other accessories may be hazardous and will render the warranty and the CE marking invalid.</p>
	<p>Never open the telephone or a key module. Should you encounter any problems, contact your service personnel.</p>

Trademarks

	<p>The device conforms to the EU directive 1999/5/EC as attested by the CE marking.</p>
	<p>All electrical and electronic products should be disposed of separately from the municipal waste stream via designated collection facilities appointed by the government or the local authorities.</p> <p>Proper disposal and separate collection of your old appliance will help prevent potential damage to the environment and human health. It is a prerequisite for reuse and recycling of used electrical and electronic equipment.</p> <p>For more detailed information about disposal of your old appliance, please contact your city office, waste disposal service, the shop where you purchased the product or your sales representative.</p> <p>The statements quoted above are only fully valid for equipment which is installed and sold in the countries of the European Union and is covered by the directive 2002/96/EC. Countries outside the European Union may impose other regulations regarding the disposal of electrical and electronic equipment.</p>

Location of the telephone

- The telephone should be operated in a controlled environment with an ambient temperature between 5•C and 40•C.
- To ensure good speakerphone quality, the area in front of the microphone (front right) should be kept clear. The optimum speakerphone distance is 50 cm.
- Do not install the telephone in a room where large quantities of dust accumulate; this can considerably reduce the service life of the telephone.
- Do not expose the telephone to direct sunlight or any other source of heat, as this is liable to damage the electronic components and the plastic casing.
- Do not operate the telephone in damp environments such as bathrooms.

Product support on the internet

Information and support for our products can be found on the Internet at: <http://www.siemens-enterprise.com/>.

Technical notes, current information about firmware updates, frequently asked questions and lots more can be found on the Internet at: <http://wiki.siemens-enterprise.com/>.

Contents

Important information2

Trademarks	2
Location of the telephone	3
Product support on the internet	3

General information.....11

About this manual	11
Symbols used in the manual	11
Service.....	12
Intended use	12
Telephone type	12
Speakerphone quality and display legibility	12
Single-line telephone/multi-line telephone.....	13

Getting to know your OpenStage phone14

The user interface of your OpenStage 40/40 G.....	14
Ports on the underside of the phone.....	15
Using network ports more efficiently	16
Key Module	17
OpenStage Key Module.....	17
OpenStage Key Module 15	18
Keys.....	19
Function keys.....	19
Audio keys	19
Navigator	20
Programmable sensor keys	21
Trunk keys (on multi-line phones only).....	22
Keypad	24
Display.....	26
Idle mode.....	26
Idle-display view and icons	26
Context-dependent displays	27
Telephony interface.....	29
Single-line view	29
Multi-line view	30
Phonebooks.....	32
Personal phonebook	32
LDAP directory.....	33
Messages	34
Voicemail	34
Calls	35

Telephone menu	37
Program/Service menu	37
User settings	37
Administration	38
Control and monitoring function	38
Contributing to environmental protection by saving energy	39

Basic functions 40

Secure voice transmission.	40
Answering a call	40
Answering a call via the handset	41
Answering a call via the loudspeaker (speakerphone mode).	41
Answering a call via the headset	42
Directed pickup	43
Accept call	43
Picking up the held call	44
Switching from handset to speakerphone mode	45
Switching from speakerphone mode to the handset	45
Switching from headset to speakerphone mode	46
In standard mode.	46
In U.S. mode	46
Open listening	46
Activating/deactivating the microphone	47
Ending a call.	47
Group call.	48
Making calls.	51
Off-hook dialing	51
On-hook dialing	52
Immediate dialing.	53
Dialing using the hot or warm line function	54
Redial.	55
Consulting a second party	56
Switching to the held party (alternating)	57
Putting on hold and retrieving successively or simultaneously	58
Connecting parties.	59
Call forwarding.	60
Programming call forwarding.	61
Activating/deactivating call forwarding.	63
Activating call forwarding for all calls.	64
Call forwarding chain	65
Callback	66
Requesting callback	66
Responding to a callback	67
Permitting callback on busy/no reply	68
Calling back missed calls.	69

Programmable sensor keys70

List of available functions	70
Programming sensor keys	71
Beginning programming	71
Beginning programming	72
Programming enhanced functions.	72
Repertory dial.	72
Feature toggle	74
Forwarding.	75
Using sensor keys	76
Example 1: Calling saved number	76
Example 2: Call Waiting toggle Activating/deactivating	76
Example 3: Immediate ring	76
Resetting sensor keys.	77

Enhanced phone functions.78

Incoming calls	78
Accepting calls via the headset	78
Deflecting a call	78
Rejecting a call.	80
Configuring call forwarding	80
Placing a call on hold	82
Call waiting (second call)	86
Transferring a call.	90
CTI calls	93
Making calls.	95
Dialing with the DDS key.	95
Dialing from the local phonebook	95
Dialing from the LDAP database	95
Dialing a phone number from a list	96
Using autodial delay.	97
Conference	100
Local conference	100
System-based conference.	103

Phonebooks and call lists105

Local phonebook	105
Creating a new contact	105
Editing a contact	105
Deleting a contact	106
Deleting all contacts.	106
Searching for a contact	107

LDAP database	108
Finding an LDAP entry	108
Extended LDAP editing	109
Quick search	110
Call lists	111
Editing entries	111
Delete all entries	111

Making calls with multiple lines 112

Incoming calls	112
Accepting calls for the primary line	112
Accepting calls for secondary lines	112
Making calls	113
Manual trunk seizure	113
Automatic trunk seizure	114
Dialing the last dialed number	114
Forwarding calls on primary line	114
During calls	115
Making and receiving calls on a single line	115
Making and receiving calls with multiple lines	115
Putting a line on hold	116
Lines with hot or warm line function	117
Busy override	118
Direct station selection keys	119
Calling a station directly	119
Call pickup	120
Deflecting a call to a DSS station	121
LED display on DSS keys	121
Making calls in an executive-secretary team	122
Sample scenarios	122
Accepting a call	124
Connecting a call	125
DSS keys can be used	127
Using line overview	127
Settings for MultiLine (keyset)	128
Displaying the line in the "Overview" tab	128
Setting the time for a delayed ringer	129
Configuring the "Overview" tab display	130
Line preview	131
Rollover for a line	132

Privacy/security133

Deactivating the ringer	133
Do not disturb	134
Enabling do not disturb via a key	134
Enabling do not disturb via the idle menu	134
Allowing "Do not disturb"	135
Security	136
User password	136
Phone locking	138

Mobility140

Mobility scenarios	140
Logging on and off at the same phone	140
Logging on and off at different phones	140
Logging on and off at the same phone	141
Logging on to the phone	141
Logging off from the phone	142
Logging on at different telephones	143
Logging on with forced logoff at a remote phone	143
Logging on with forced, delayed logoff at a remote phone	144

OpenScope Voice functions.....145

Feature toggle key	145
Making anonymous calls	146
Deactivating	146
Activating	146
Temporarily activating anonymous calling for the next call	147
Temporarily deactivating anonymous calling for the next call	147
Creating a list for selective calls	148
For call acceptance	148
For call rejection	149
Anonymous calls	150
Rejecting	150
Accepting	150
Using abbreviated dialing	151
Call tracing	151
Hunt group functions	152
Making a line busy	152
Marking the last line in the hunt group chain	153
Reachability	154
Serial call	154
Parallel call	155
Parking a call	157
Call park	157
Unparking	157

Silent Monitoring	158
Active silent monitoring	158
Muted silent monitoring	159
Code table for OpenStage Voice functions	160

Individual phone configuration 161

Display	161
Adjusting the display to a comfortable reading angle	161
Setting contrast	161
Adjusting the brightness	162
Background lighting	163
Contrast for the OpenStage Key Module	164
Date and time	165
Setting the time	165
Setting the date	165
Setting daylight saving time	166
Automatic daylight saving time	167
Time display format	168
Date display format	168
Audio	169
Volumes	169
Settings	170
Tone and indication with an unsecured voice connection	175
Key click	176
Setting the language and country	177
Selecting a language	177
Country-specific setting	179
Context menu	181
Activating/deactivating automatic menu display	181
Setting the display time	181
Network information	182
Resetting user data	183
Initiating the reset	183

Call recording 184

Call recording modes	184
Explanations of recording	185
Recordable calls	185
Non-recordable calls	185
Enhanced functions:	186

The following features are not supported:	186
Recording tips	186
Multiline	186
Recording calls	187
Using the call recording feature	187
Automatic call recording	187
Manual call recording	188
Call recording with AutoStart	188
Controlling call recording	189
Consultation during call recording	189
Second call during call recording	190
Call recording while alternating	191
Your call is paused and reconnected during the recording.	191
Setting up a conference during recording	192
Adding conference participants during the recording	192
Your call is included in a conference during the recording.	193
Putting a line on hold manually during the recording.	193

Web interface (WBM)295

General	195
Calling up the Web interface	195
Administrator Pages	195
User pages.	196
User menu.	197

Fixing problems201

Caring for your telephone	201
Troubleshooting.	201
Contact partner in the case of problems	202
Labeling keys.	202

Local user menu203

Opening the user menu on the phone	203
User menu display.	203
Key functions	211

Index.213

General information

About this manual

This document contains general descriptions of the technical options, which may not always be available in individual cases. The respective features must therefore be individually defined in the terms of the contract.

If a particular function on your phone is not available to you, this may be due to one of the following reasons:

- The function is not configured for you or your telephone. Please contact your system support representative.
- Your communications platform does not feature this function. Please contact your Siemens sales partner for information on how to upgrade.

This user guide is intended to help you familiarize yourself with OpenStage and all of its functions. It contains important information on the safe and proper operation of your OpenStage phone. These instructions should be strictly complied with to avoid operating errors and ensure optimum use of your multifunctional telephone in the network.

These instructions should be read and followed by every person installing, operating or programming an OpenStage phone.



For your own protection, please read the section dealing with safety in detail. Follow the safety instructions carefully in order to avoid endangering yourself or other persons and to prevent damage to the unit.

This user guide is designed to be simple and easy to understand, providing clear step-by-step instructions for operating your OpenStage phone.

Administrative tasks are dealt with in a separate manual. The Quick Reference Guide contains quick and reliable explanations of frequently used functions.

Symbols used in the manual

Settings

Operations and settings that can be made both at the phone and over the Web interface are indicated by an icon and page reference.







is a reference to an operation or setting performed directly on the phone



is a reference to an operation or setting performed via the Web interface

Call recording

-  Switch on recorder (standby mode)
-  Switch off recorder
-  Start recording
-  Stop recording

Service



The Siemens service department can only help you if you experience problems or defects with the phone. Should you have any questions regarding operation, your specialist retailer or network administrator will gladly help you. For queries regarding connection of the telephone, please contact your network provider.

If you experience problems or defects with the phone, please dial the service number for your country.

Intended use

The OpenStage phone is a desktop unit designed for voice transmission and for connection to the LAN. It can also be used as a workstation device. Any other use is regarded as unauthorized.

Telephone type

The phone name data can be found on the name plate on the base of the device; The exact product name and serial number are specified here. Specific details concerning your communications platform can be obtained from your service technician.

Please have this information ready when you contact our service department regarding faults or problems with the product.

Speakerphone quality and display legibility

- To ensure good speakerphone quality, the area in front of the telephone (front right) should be kept clear.
The optimum handsfree distance is 20 in. (50 cm).
- Proceed as follows to optimize display legibility:
 - Turn the phone to tilt the display. This ensures you have a frontal view of the display while eliminating light reflexes.
 - Adjust the contrast as required → page 161.

Single-line telephone/multi-line telephone

Your OpenStage 40 is a "multi-line telephone". This means that multiple lines can be configured, which is not the case with single-line phones. Each line is assigned an individual phone number which you can use to make and receive calls.

The programmable sensor keys function as line keys on multi-line phones → page 22.

The "Overview" tab on the telephony interface provides information about the lines configured on your phone and the current status of each line → page 30.

A number of specific features must be considered when using a multi-line phone to make and receive calls → page 112.

Getting to know your OpenStage phone

The following sections describe the most frequently used operating elements and the displays on your OpenStage phone.

The user interface of your OpenStage 40/40 G



1	You can make and receive calls as normal using the handset .
2	The graphic display permits intuitive operation of the phone → page 26.
3	You can customize your telephone by assigning phone numbers and functions to the programmable sensor keys → page 26.
4	You can use function keys when conducting a call to access frequently used functions (such as, Disconnect) or to open the Program/Service menu and mailbox → page 19.
5	Audio keys are also available, allowing you to optimally configure the audio features on your telephone → page 19.
6	The 5-way navigator is a convenient navigation tool → page 20.
7	The keypad can be used to enter phone numbers and text → page 24.
8	Incoming calls are visually signaled via the call display .

Ports on the underside of the phone

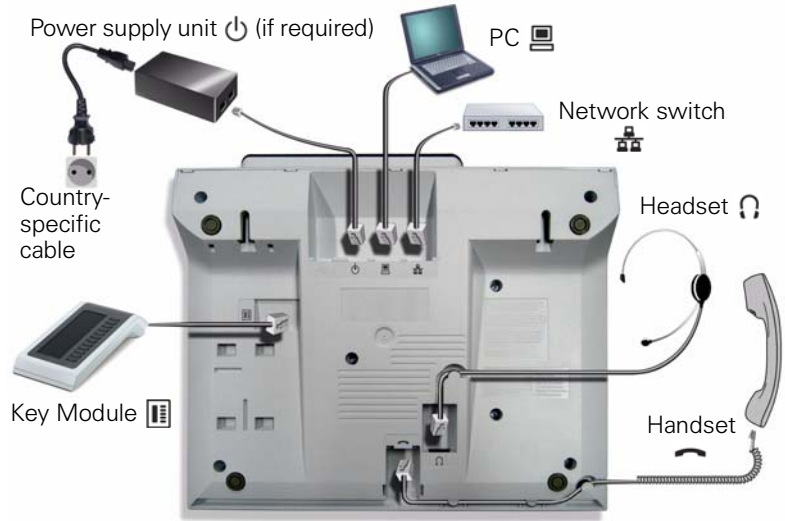

Properties of your OpenStage 40/40 G

	OpenStage 40	40 G
LCD display, 40 x 6 characters	✓	✓
Illuminated display	✓	✓
Programmable sensor keys	6	6
Full-duplex speakerphone function	✓	✓
Headset	✓	✓
10/100 Mbps Ethernet switch → page 16	✓	-
1000 Mbps Ethernet switch → page 16	-	✓
Interface for key modules	✓	✓
Wall mounting	✓	✓

Using network ports more efficiently

OpenStage 40 has a built-in 10/100 Mbps Ethernet switch. OpenStage 40 G has a 1000 Mbps Ethernet switch. This means that you can connect a PC to the LAN directly via the phone. The telephone-PC connection option must first be activated on the telephone by service personnel.



Using this connection option saves one network port for each switch used and requires fewer or shorter network cables when arranged correctly.

Key Module

OpenStage Key Module

The OpenStage Key Module is a key module attached to the side of the phone that provides 12 additional illuminated, programmable keys. Like keys on the phone, these keys can be programmed and used according to your needs → page 21.



You can attach up to two OpenStage Key Modules to your OpenStage 40.



To operate an OpenStage Key Module, you always require a power supply unit → page 2.

OpenStage Key Module 15

The OpenStage Key Module 15 is a key module attached to the side of the phone that provides an additional 18 illuminated, programmable sensor keys.

Like keys on the phone, these keys can be programmed and used according to your needs. Labeling keys see → page 202.

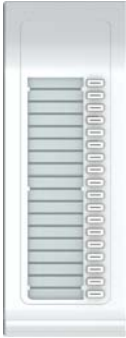



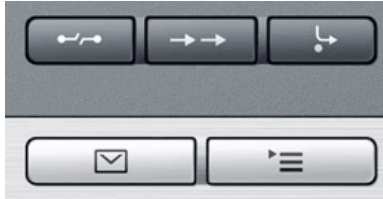

You can only attach one OpenStage Key Module 15 to your OpenStage 40. You **cannot** combine the OpenStage Key Module 15 with the OpenStage Key Module.

Keys





Function keys

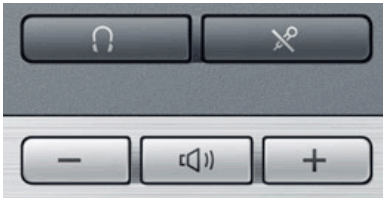

Key	Function when key is pressed	LED display
	End (disconnect) call.	none
	Open redial list	none
	Activate/deactivate forwarding	Red: Call forwarding is activated
	Open phone menu → page 37	Red: Menu is active
	View messages → page 34	Red: New voicemail or missed calls

Audio keys













Key	Function when key is pressed
	Activate/deactivate microphone (also for speakerphone mode)
	Activate/deactivate the headset.
	Decrease the ring, handset, and loudspeaker volume.
	Activate/deactivate loudspeaker for speakerphone mode and open listening
	Increase the ring, handset, and loudspeaker volume.

Navigator

 Before using the telephone, remove the protective covering from the navigator surface.

With this control, you can manage most of your phone's functions, as well as its displays.

Operation	Functions when key is pressed
 Press the  key.	<ul style="list-style-type: none"> • Call up the context menu • Perform action • Go down a level • Call up the context menu in the idle display
 Press the  key.	<ul style="list-style-type: none"> • Short press: One level back • Long press (held down): Go back to the first level of the settings menu • Cancel function • Quit the context menu • In input fields: Delete character to the left of the cursor • Open line overview in idle mode
 Press the  key.	<ul style="list-style-type: none"> • Scroll downwards • Select element below • Long press (held down): Jump to the end of the list/menu
 Press the  key.	<ul style="list-style-type: none"> • Scroll upwards • Select element above • Long press (held down): Jump to the start of the list/menu
 Press the  key.	<ul style="list-style-type: none"> • Confirm input • Perform action • Call up the context menu

Programmable sensor keys

Your OpenStage 40 telephone features six programmable lit sensor keys.

 Increase the number of programmable sensor keys by connecting a key module → page 17.

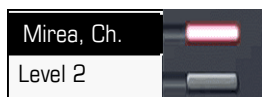

Touch the key briefly to activate the programmed function or dial the stored number → page 76.

If you hold the key pressed, you are prompted as to whether to start programming this function key.

 If the prompt is not displayed or a programmed function is not executed, then you can only launch key programming via the user menu → page 71 (ask your service personnel about the current setting).

 Only for redial keys can you also program the second level for direct destination selection.



You can label these keys with internal and external phone numbers or frequently used functions (platform-dependent; please contact the responsible service personnel).

The configured phone number or function name is displayed next to the key.

The status of a function is shown by the LED on the corresponding sensor key.

 Line and DDS keys can only be programmed by service personnel via the service menu.

Meaning of LED displays on function keys

LED	Meaning of function key
 Off	The function is deactivated.
 Flashing ¹	Indicates the function status.
 On	The function is activated.

[1] In this manual, flashing sensor keys are identified by this icon, regardless of the flashing interval. The flashing interval represents different statuses, which are described in detail in the corresponding sections of the manual.

Trunk keys (on multi-line phones only)

The programmable sensor keys on multi-line phones function as trunk keys. Each key programmed with the "Line" function is handled as a line. This means up to five lines can be configured.

A distinction is drawn here between primary, secondary and phantom lines. Each of these line types can be used on a private or shared basis → page 22.

Primary line

All multi-line telephones have a primary line. This line can be reached in the usual manner via your public phone number. Incoming calls are signaled on this line.



To avoid conflict between individual multi-line phones, the functions "Do not disturb" and "Call forwarding" can only be used for the primary line.

Secondary line

The secondary line on your phone is used as a primary line by another subscriber of the line trunk group. Your primary line, which is configured on another telephone in the line trunk group, simultaneously functions as the secondary line on that telephone.

Phantom line



Phantom lines are not used as primary lines by any telephones in the line trunk group. Phantom lines are established when the number of lines provided by a communications system exceeds the number of available telephones.

Line utilization

- **Private line:** A line that is used by a single telephone. This line cannot be used as a secondary line by another telephone.
- **Shared line:** A line that is configured on multiple telephones. The line status (if configured) is displayed in the "Overview" tab for all telephones that share this line. If, for example, a shared line is being used by a telephone, a status message indicating that this line is busy is displayed on all other telephones.
- **Direct call line:** A line with a direct connection to another telephone.

The line status is indicated by the LED in addition to the display in the "Overview" tab → page 30.

LED display

LED		Explanation
	Not lit	The phone is in idle mode.
	Flashing	<ul style="list-style-type: none"> • Incoming call on the line (→ page 112) • "Hold reminder" is activated (→ page 83)
	Flickering	<ul style="list-style-type: none"> • Outgoing call on the line • The incoming call was prioritized and selected in accordance with the "Automatic line selection for incoming calls" option
	Fast blinking	The line is on "Hold"
	Blinking	Call forwarding is activated
	Illuminated	The line is busy

Keypad

You can only use the digits 1 to 9 and 0 as well as the * and # characters when dialing a number. The  navigation key is used to delete from right to left.

In cases where text input is possible, you can use the keypad to input text, punctuation and special characters in addition to the digits 0 to 9 and the hash and asterisk symbols. To do this, press the numerical keys repeatedly.











Example: To enter the letter "h", press the number  key on the keypad twice. When entering the text, all available characters for this key are displayed. After a short while, the character in focus is displayed in the input field.



To speed up the input, you can confirm your entry by pressing "" on the navigator after you have selected the required character.

To **enter a digit** in an alphanumeric input field, press the relevant key and hold it down. You no longer need to scroll through the entire list of possible characters.

Character overview (depends on the current language setting)



Key	1x	2x	3x	4x	5x	6x
]	1				
	a	b	c	2	ä	
	d	e	f	3		
	g	h	i	4		
	j	k	l	5		
	m	n	o	6	ö	
	p	q	r	s	7	ß
	t	u	v	8	ü	
	w	x	y	z	9	
	0					
	[1]	[2]				

[1] Next letter in upper case (active for maximum one second)

[2] Switch to digit input

	.	,	?	!	'	"	-	()	@	/	:	_						
---	---	---	---	---	---	---	---	---	---	---	---	---	---	--	--	--	--	--	--

Multi-function keys

Key	Function during text input	Function when held down
	Write special characters.	Deactivate the ring tone
	Switch between upper and lower case	Activate the telephone lock.

Alphabetic labeling of dial keys is also useful when entering vanity numbers (letters associated with the phone number's digits as indicated on the telephone spell a name, e.g. 0700 - PATTERN = 0700 - 7288376).

Text editor

A function menu appears under the character selection field in certain situations (such as, when labeling programmable sensor keys). You can enter punctuation marks and special characters and switch between the entry of alphanumeric characters in lower and upper case and straightforward digit entry.

You can select further editor functions via the **navigator**:



- OK – Confirm and terminate the entire input
- Cancel – Cancel your entries without saving
- Mode Configuration via the key 
 - 123 (# -> ABC) – Numerical entry
 - ABC (# -> Abc) – Upper-case characters
 - Abc (# -> abc) – Initial character upper case
 - abc (# -> 123) – Lower-case characters
- Move cursor left to add or delete characters
- Move cursor right to add or delete characters
- Copy – Copy a visible character string
- Paste – Insert a copied a character string at a cursor position

Display

Your OpenStage 40 comes with a tilt-and-swivel black-and-white LCD display. Adjust the tilt and contrast to suit your needs (→ page 161).

Idle mode

If there are no calls taking place or settings being made, your OpenStage 40 is in idle mode.

➡ Press the  key to return to the idle display again, for example, from a call list (→ page 34). To return to the idle display again from the phonebook (→ page 37) or the Service menu (→ page 37), press the  key. You can also configure a "Show telephone screen" function however for both cases (see → page 70) to return to the idle mode screen again.

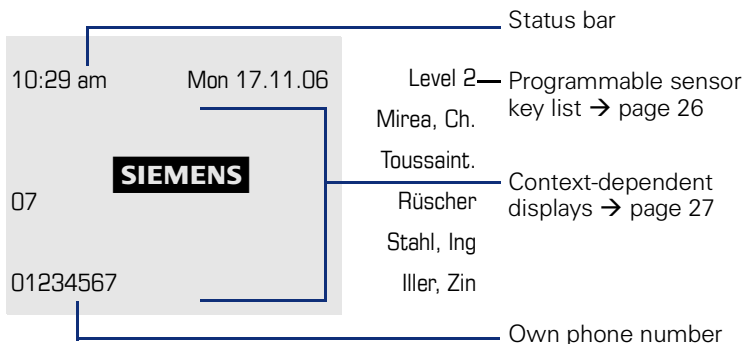





The left area contains the status bar on the first line and is followed by a five-line field for comprehensive context-specific displays. The right area is used for labeling the programmable sensor keys.

Idle-display view and icons

The time, weekday, and date are displayed in the status bar.

In addition, different icons represent different situations and switches:

Icon	Explanation
	The ring tone is deactivated.
	The "Do not disturb" function is activated.
	The phone lock is activated.
	A mobile user is logged on to the telephone.
	The microphone is deactivated.

Context-dependent displays

Depending on the situation at hand, the graphic display on your OpenStage phone displays different content, to which you can respond intuitively.

Information on actual events

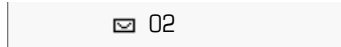

The following icons appear centered on the display when your phone is idle and signal current properties or events.

Example: You missed two calls in your absence.





You have two new voice messages that you can open by pressing  → page 34.

Icons for events

Icon	Explanation
	You received new voice messages.
	New entries have been added to the call lists.
	Local call forwarding is active.

Context menus

An arrow beside a selected entry indicates the existence of a context menu that you can open by pressing the  or  buttons on the navigator (→ page 20). The range of functions available is situation-specific.

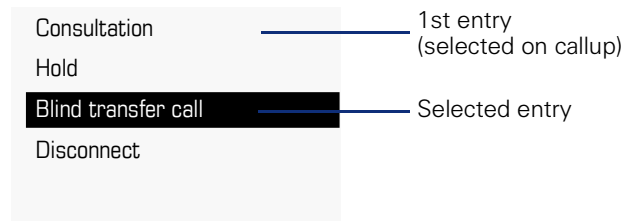

After a connection is set up – you are called or you make call – the context menu appears automatically under the current connection for the configured time (e.g. 20 seconds).

You can define how long the context menu should be displayed. You can deactivate the automatic display so that the  key on the navigator must be pressed to see the context menu of the connection → page 181.

Idle display context menu

The following functions (where released) can be accessed by pressing the right key on the navigator:

Redial {1} 1234	—	First entry (selected when you call up the menu, if you have already dialed a phone number)
Ringer off		
Do not disturb off	—	Selected entry
Mobile logon	—	Only available when configured to support mobility
Cancel call backs		
Directed pickup		

Pop-up menus

In many operating situations, suitable functions or information is offered in an automatic pop-up window.

Example: You set up a consultation call. The pop-up menu opens and offers suitable functions for selection with the navigator.

012345	Level 2
Dial	Mirea, Ch.
Redial {1}	Toussaint.
Retrieve held call	Rüscher
	Stahl, Ing
	Iller, Zin

A pop-up window automatically closes as soon as you have performed an action.

To suppress information pop-up windows, press **Ⓢ** on the navigator.

Telephony interface

Single-line view

Additional information is displayed in the telephony interface when your phone rings, when you dial a number or during a call, for instance.

 The same information is available on multi-line telephones for the selected line in the line overview.

Example:

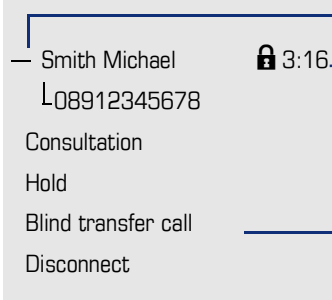

Icon indicating call status

— Smith Michael  3:16 Call duration

L08912345678 Current call(s)



Consultation

Hold



Blind transfer call

Disconnect Context menu with situation-specific options

Icons for frequent call states

Icon	Explanation
—	The call is active
⚡	The call has been disconnected
⏸	You have placed the call on hold (e.g. consultation hold).
⏸	Your call partner has placed the call on hold
	The voice connection is secure.
	The voice connection is not secure.

 Detailed descriptions of the various functions can be found in the sections "Basic phone functions" → page 40 and "Enhanced phone functions" → page 78.

 Press the  key to return to the telephony interface again, for example, from a call list (→ page 34). To return to the telephony interface again from the phonebook (→ page 37) or the Service menu (→ page 37), press the  key. You can also configure a "Show telephone screen" function however for both cases (see → page 70) to return to the telephony interface screen again.

Multi-line view

You can use the  key to switch between two tabs on the telephony interface:





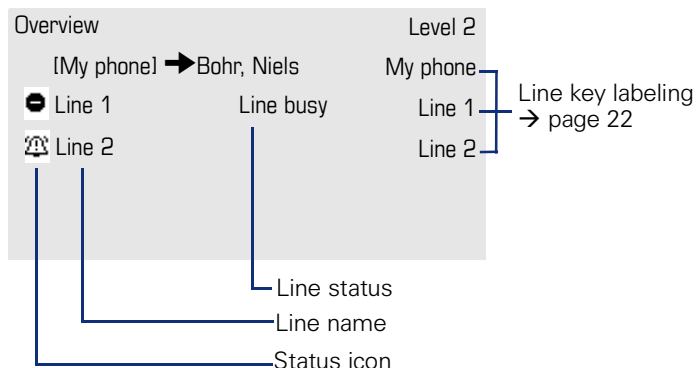

- "[My phone]" tab - represents the primary line or the line view of a selected line → page 29
- "Overview" tab - configurable overview of the secondary lines → page 22

In idle mode: Press the  key:

Example:



The status icons provide information about the state of the relevant line.

Icon	Explanation
	Call for the corresponding line.
	Call from a DSS line.
	Call for a line with suppressed ring tone → page 132.
	"Hold reminder" is activated → page 83.
	The line is currently not available.
	The line is busy.

 Please note the LED displays for the line keys → page 23.

Context in the line overview

In the context menu of a selected line you have the following options with:

- Own free line
 - Select
 - View
- Own line with active call
 - Hold
 - Clear (replace handset)
 - View¹
- Own line with held call
 - Retrieve
 - View
- Other free line
 - Select
 - View
- Other line with active call
 - Hold
 - Clear (replace handset)
 - View
- Other line with held call
 - Retrieve
 - View
- Other line busy
 - View

¹ The telephony view is displayed as a preview after a period of time set by the service personnel.

Phonebooks

In addition to a local phonebook, there is a connection to the LDAP corporate directory if service personnel have made the necessary settings.

Both phonebooks can be accessed via the telephone menu (→ page 37). You can configure a sensor key for the local phonebook.

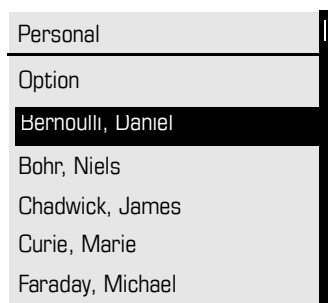

Search contacts

When in the phonebook or directory list view, press the keypad key that corresponds to the first letter of your search term. A field opens for you to enter the search term:



The cursor jumps to the first entry in the list that matches the character you entered in the search field.

Personal phonebook

You can store up to 100 private contacts in your personal phonebook. These are displayed in alphabetical order in the phonebook list. How to create contacts is described in → page 105. A contacts consists of an entry with a "Last name", "First name" and a number.

Managing contacts

All saved contacts are listed in alphabetical order on the "Personal" menu.

You can use the "Options" context menu to

- create new contacts → page 105
- delete the entire phonebook list → page 106

Using contacts

The following functions are available via the context menu of a selected contact:

- Calling a contact → page 95
- Editing a contact → page 105
- Deleting a contact → page 106

LDAP directory

If you have access to an LDAP directory (contact the responsible service personnel), you can search contacts in a company-wide directory. A user-friendly, advanced search function is available for this.

Searching for a contact

- Simple search → page 108
- Quick search → page 110.

Using a contact

Calling a contact → page 95

Messages

Depending on the type and configuration of your communications platform (contact the relevant service personnel), messages from services, such as, HiPath Xpressions can be displayed in this list.

When new messages are received, a message appears (→ page 27) on the idle display and the LED on the  (→ page 19) key lights up.

To access the menu: Press the  key and use the navigator to select and confirm the relevant submenu.





Voicemail

You will find voicemails in the **Messages directory**.

Messages Directory:

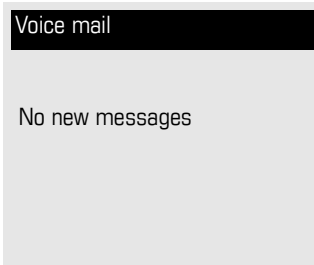
The following default entry appears in the list: **Voice mail**



Alternative call: Hold down the  key.

If your system is appropriately configured (contact the relevant service personnel), you can call the voice mailbox directly and immediately play back the messages saved.

Calls

This list appears as soon as you receive **new** missed calls if you select the option **Calls** in the Records menu. You can then scroll back to the **Calls** menu with the backspace key. The following calls or call attempts are logged as call lists:

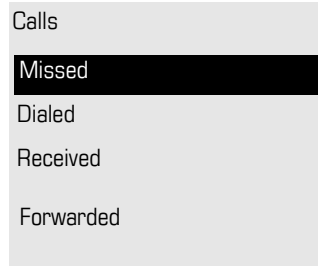

The number of missed calls and unchecked calls is shown on the idle display.

Call lists

All calls to your phone are time-stamped and logged in consecutive order in the call lists.

Each call list may contain up to 30 entries. Once this limit is reached, the oldest entry in the log is deleted.

Multiple calls from the same number are only listed once. The number of call attempts is logged in the "Details" context menu and additionally in the "Missed Calls" log in the list display.

The list contains the phone number as well as the time of the last call.



If you connected a call partner with his/her consultation or second call partner, his/her phone number will be shown in the call list "Received".



Callers with suppressed numbers are listed as "Unknown" in the call lists.



Only calls to the primary line are received on multi-line phones (→ page 13).

Example of the **Missed** call list:

Missed	
Options →	
(Busch, Wilhelm	12:11
└11178	(2)
(Benz, Karl →	10:25
└235689	(1)
(Lessing, Ephraim	7:22
└2568900	(1)

Time of call

Number of call attempts

Selected new entry with context menu

Old entry

Call list options

You can select the following function in the **Options** context menu:
Delete all → page 111

Entry-specific context menu

You can select the following functions for an individual entry:

- Dial → page 96
- Details → page 111
Call attempts with date and time (up to ten can be saved)
- Delete → page 111

Telephone menu

Open the telephone menu using the  key.

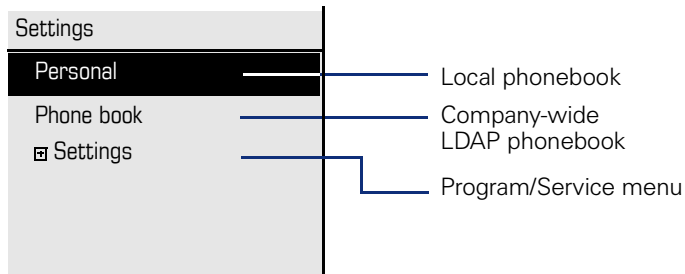

Program/Service menu

You can make settings here as a user and use this menu to navigate to the password-protected administration area.

Accessing the menu: **Settings** select and confirm and then select and confirm the required menu using the navigator.

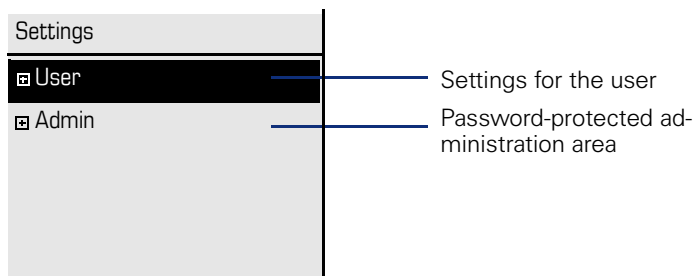

User settings

You can use the "User" menu to make local function settings for your OpenStage and to configure the appearance of your display to your personal requirements.

Select one of the following menus with the navigator (→ page 20):

- "Date and time" → page 165
- "Audio" → page 169
- "Configuration" e.g. → page 79 or → page 101
- "Phone" → page 70 → page 161
- "Locality" → page 165
- "Security" → page 136
- "Network information" → page 38
- "Reset" → page 183

Network information

Information about the IP address or name which was assigned to the phone in the network and therefore the HTML address of the web interface.



View information on the phone → page 182



Contact your service personnel or refer to the OpenStage Administration Manual for more on the network information values listed here.

Perform reset



Personal settings made via the telephone menu or the web interface can be reset to factory settings. → page 183

Administration

You can access the administration area via the "Admin" function and by entering the administration password.

Refer to the administration manual supplied with your phone for more detailed information on this topic.

Control and monitoring function

A control or monitoring function can be activated on your phone for service purposes by remote maintenance.

Control function

Service personnel have the option to activate and deactivate features of the phone via remote maintenance. During maintenance the handset, microphone, loudspeaker and headset are deactivated. You are additionally informed on the display that the control function is active.

Monitoring function

In order to detect malfunctioning of a phone for example, the service personnel install a monitoring function. You can use your phone as normal during monitoring. However you will first be informed about the operation with a message on the display and prompted to allow monitoring.

If service personnel have activated a function on your phone, which continuously transmits operating data to a server, you will see the flashing icon  in the upper display line.

Contributing to environmental protection by saving energy

The user can save energy actively using the energy settings on the telephone and in this way contribute to protecting the environment.

To reduce energy consumption, you can

- reduce the brightness of the display (the default setting is 50 percent and is preset → page 162).
- set the background lighting to switch off automatically after a certain period of time. To save a large amount of energy, the time can be reduced to one minute. The default value is 5 minutes (→ page 163).
- reduce the ring volume (set by default to 50 % → page 169).

Step by step

Basic functions

 Please read carefully the introductory chapter "Getting to know your OpenStage phone" → page 14 before performing any of the steps described here on your phone.

Secure voice transmission

Prerequisite: The secure voice communication option must be activated by your service personnel.

If you call a party or receive a call from a party over a secure connection, a padlock icon¹ appears on the other party's row on your graphic display. You can opt to have voice connections that are no longer secure indicated by a brief alerting tone and a window with the message "Unencrypted call" (see → page 175).

Answering a call

Your OpenStage phone rings with the tone signal set when an incoming call is received. The call is also visually signaled on the call display.

If transmitted, calling party information (name, phone number) appears on the graphic display.

 If you have set a pattern melody or a ringtone → page 171 on your phone, it is possible that service personnel have preset a different ringtone or deactivated the ringtone, depending on the call type (e.g. an external or internal call).

An incoming call will interrupt any ongoing telephone setting operations. When the call ends, you can press the  key to return to the point in the menu structure where you were interrupted.

1. Closed for secure or open for nonsecure voice communication

Step by step

Answering a call via the handset

The phone is ringing. The caller is displayed.

Lift the handset.

Set the call volume.

if nec.  

**Answering a call via the loudspeaker (speakerphone mode)**

The phone is ringing. The caller is displayed.

The pop-up menu opens:

Accept?

Select and confirm the option shown. The  key lights up.

or



Press the key shown. The key lights up.

The speakerphone function is activated.

Set the call volume.

if nec.  

Suggestions for using speakerphone mode:

- Tell the other party that speakerphone mode is active.
- Adjust the call volume while speakerphone mode is active.
- The ideal distance between the user and the phone in speakerphone mode is 50 cm.

Step by step

Answering a call via the headset

Prerequisite: A headset is connected.



Make sure your headset port is set up properly
→ page 174.

The phone is ringing. The  key flashes.



Press the key shown.

if nec.



Set the call volume.

Answering calls automatically via the headset

Prerequisite: The service personnel have additionally configured a key with the "Auto-Headset function (AICS Zip tone) (→ page 70).



Press the "Auto-Headset" sensor key to activate automatic call answering. This key and the headset key illuminate.

A short acoustic signal is heard on the headset for a call and the connection is established.

If you want to manually answer calls again, deactivate the automatic answering function using the "Auto-Headset" key. Both keys are off.

Step by step

Directed pickup

You can pick up a call signaled at an absent coworker's phone. If a colleague has placed a call on hold on their multi-line phone you can also pick up this call.

Accept call

Prerequisite: You know the coworker's internal phone number and the function is configured for you in Open-Scape Voice.

A coworker's phone rings.

Directed pickup?

Select and confirm the option shown in the idle phone's context menu.

or



Lift the handset.

or



Press the key shown.

Directed pickup?

Select and confirm the option shown.



Enter and confirm the relevant phone's internal number. You are connected to the calling party either via the handset or in speakerphone mode.

Step by step

Picking up the held call

Prerequisite: Your colleague has placed a call on hold on their multiline phone → page 116.. You know the co-worker's internal phone number and the function is configured for you in OpenScape Voice.

Directed pickup? ⚡

Select and confirm the option shown in the idle phone's context menu.

or



Lift the handset.

or



Press the key shown.

Directed pickup? ⚡

Select and confirm the option shown.



Enter and confirm the relevant phone's internal number. You are connected to your colleague's held call either via the handset or in speakerphone mode.

Step by step

Switching from handset to speakerphone mode



Make note of the two different processes and activate your preferred setting as required
→ page 173.

Prerequisite: You are conducting a call via the handset and the microphone and loudspeaker functions have been activated by service personnel.

Open listening in standard mode



and



Hold down the key and replace the handset. Then release the key and proceed with your call.

Open listening in US mode

If open listening is set to US mode, you do not have to hold down the loudspeaker key when replacing the handset to switch to speakerphone mode.



Press the key shown.



Replace the handset. Proceed with your call.



A secure voice communication is indicated by a closed padlock icon on the graphic display; a non-secure voice communication is indicated by an open padlock icon on the graphic display (see also → page 40)

Switching from speakerphone mode to the handset

Prerequisite: You are conducting a call in speakerphone mode.



Lift the handset.



The key shown goes out.

Step by step

Switching from headset to speakerphone mode

In standard mode



Press and hold the key (open listening is activated),



Press the key shown. Speakerphone mode is activated.

In U.S. mode



Press the key shown.



Press the key shown. Speakerphone mode is activated.

Open listening

You can let other people in the room join in on the call. Let the other party know that you have turned on the loudspeaker.

Prerequisite: You are conducting a call via the handset.

Activating



Press the key shown.

Deactivating



Press the lit key.

Switching to speakerphone mode



Hold down the lit key and replace the handset.

Step by step

Activating/deactivating the microphone

You can temporarily switch off the handset microphone to prevent the other party from listening in while you consult with someone in your office.

Prerequisite: You are conducting a call.

Deactivating the microphone



Press the key shown.

Activating the microphone



Press the lit key.

Ending a call



Press the key shown.

or

Disconnect?

Select and confirm the option shown in the connections's context menu.

or



Lit key pressed

or

In speakerphone mode



Press the lit key.

Step by step

Group call

Your service personnel can incorporate multiple telephones in a call pickup group. If your telephone belongs to a pickup group, you can also accept calls intended for other members of the group.

A group call is displayed on the phone. Service personnel may have made the following settings for signaling:

Telephone status			Ring on group call = Yes	Ring on group call = No
Ringer on	Silent		Ringtone Loudspeaker	Beep Loudspeaker
	in Connection	Handset	Ringtone Loudspeaker	Beep Handset
		Handset Open listening	Beep Handset and loudspeaker	Beep Handset and loudspeaker
		Headset	Ringtone Loudspeaker	Beep Headset
		Headset Open listening	Beep Headset and loudspeaker	Beep Headset and loudspeaker
		Speaker-phone mode	Beep Loudspeaker	Beep Loudspeaker
Ringer off	Silent		Nothing	Nothing
	in Connection	Handset	Nothing	Beep Handset
		Handset Open listening	Beep Handset and loudspeaker	Beep Handset and loudspeaker
		Headset	Nothing	Beep Headset
		Headset open listening	Beep Headset and loudspeaker	Beep Headset and loudspeaker
		Speaker-phone mode	Beep Loudspeaker	Beep Loudspeaker

The volume settings can be found from → page 169.

Step by step

Further service personnel settings for group calls:

- The group call can be picked up both by lifting the handset and via the "Pickup call" menu option.
- The group call be picked up via the "Pickup call" menu option but **not** by just lifting the handset.
- A key is programmed for call pickup.
- A pop-up menu is opened with the Call pickup key when a group call is waiting.

Picking up a group call with the call pickup key

Prerequisite: The Call pickup key is configured. Your service personnel have set up the group call such that it is only displayed through flashing of the Call pickup key. The phone can also ring when idle.

A group call is waiting. The Call pickup key flashes. The group call is not shown on the display.



Press the sensor key with the "Call pickup" function.

The group call is now shown on the display with

Pickup: *Caller*

for: *Station*

The pop-up menu opens:

Picking up a group call immediately via the pop-up menu

Prerequisite: Your service personnel have set up the group call such that it will be shown immediately on the display and the pop-up menu will open.

A group call is waiting and is shown on the display with

Pickup: *Caller*

for: *Station*

Step by step

Pickup call?

or



or



Picking up a group call

The pop-up menu opens:

Confirm.

Lift the handset (only if the appropriate function is set by your service personnel)

Press the sensor key with the "Call pickup" function or press it again if call answering was initiated via the key. The speakerphone function is activated.

Ignore?

Ignoring a group call

Select and confirm the option shown. The phone stops signaling the group call.

Step by step

Making calls

 If you selected the option "Busy When Dialing" → page 99, you will not be interrupted by an incoming call. In this case, the caller hears the busy signal.

Off-hook dialing



Lift the handset.

Enter the number if nec. Use the navigator → page 20 to correct entries as necessary.

In the pop-up menu:

Dial

Confirm or wait until the dial delay expires (see → page 97).

or

Redial {1} S. Hawking

In the pop-up menu:

Select and confirm the option shown.

The connection is set up.

 If you are using a dial plan and Immediate dialing is set (see → page 53), dialing is automatically performed as soon as the character string entered matches an entry in the dial plan.

Step by step

On-hook dialing

The connection is set up with on-hook dialing via the loudspeaker (speakerphone mode) or via a connected headset.



Press the key shown.

or



Press the key if a headset is connected.

and/or



Enter the station number.



Press or wait until the dial delay expires (see → page 97).

or

In the pop-up menu:

Redial {1} S. Hawking

Confirm.

First enter the number

First enter the number. The loudspeaker or headset key illuminate when you enter the first digit.



Enter the station number. If nec. Use the navigator → page 20 to correct entries as necessary.

Dial

Confirm or wait until the dial delay expires (see → page 97).

The connection is set up.



If you are using a dial plan and Immediate dialing is set (see → page 53), dialing is automatically performed as soon as the character string entered matches an entry in the dial plan.

Step by step

Immediate dialing

Immediate dialing should only be activated if service personnel has configured and approved a dial plan.

Immediate dialing is deactivated by default. For this reason after entering the number you must either confirm the "Dial" option or wait until the dial delay expires to set up the connection. If **Immediate dialing** is configured, your call is automatically dialed as soon as the string entered matches an entry in the dial plan.

Activating or deactivating immediate dialing



You can also configure this setting via the Web interface → page 195.



Press the key shown.

Settings

Select and confirm the option shown.

User

Select and confirm the option shown.

if nec.

Enter and confirm the User password.

Configuration

Select and confirm the option shown.

Outgoing calls

Select and confirm the option shown.

Immediate dialing

Select and confirm the option shown.

Yes

Select and confirm the option shown in the context menu.

Save & Exit

Confirm

Step by step

Dialing using the hot or warm line function

Your service personnel can configure a hot or warm line for your phone.

If you lift the handset of the phone or press the loud-speaker key

- with a hot line immediately or
- with a warm line after a defined period of time,
- a number specified by service personnel is dialed.

Examples:

- The phone in the lift immediately dials the reception number.
- The phone at a patient's bed dials the ward number e.g. after a minute if no other number is dialed.

Step by step

Redial

Redialing from the call list

 Only calls to the primary line are received on multi-line phones (→ page 13).



Press the key shown.

You are automatically directed to the **Dialed** list in the **Calls** menu.

Niels, Bohr 07:06 am

Select and confirm the entry you want. The phone number associated with the list entry is dialed.

Redialing from the pop-up menu



Lift the handset.

or



Press the key shown.

Redial {1} S. Hawking

Confirm.

The last phone number entered is dialed.

Redial {1} S. Hawking

Redialing from the idle menu

Select and confirm from the idle display context menu (→ page 28). The last phone number entered is dialed.



 A secure voice communication is indicated by a closed padlock icon on the graphic display; a non-secure voice communication is indicated by an open padlock icon on the graphic display (see also → page 40)

Step by step

Consult

or

Konferenz starten



Disconnect & return

Disconnect

Consulting a second party

You can call a second party while a call is in progress. The connection to the first party is placed on hold.

Prerequisite: You are conducting a call.

Select and confirm the option shown in the connections's context menu.

Start conference

Select and confirm the option shown in the context menu for the call connection when you intend to set up a conference with the new participant. You can also use an already configured **Conference** key in this instance.

Call the second party.



If you are using a dial plan and Immediate dialing is set (see → page 53), dialing is automatically performed as soon as the character string entered matches an entry in the dial plan.

Ending or canceling a consultation call

Select and confirm the option shown in the second party's context menu.

The consultation call is disconnected. The call with the first party is resumed.

Ending the first call

Select and confirm the option shown in the first call's context menu.

The connection to the second party remains active.



If you want to use the **phonebook** or a **call list** for the consultation, select **Hold** in the context menu instead of Consult or press the **Hold** key and then select the required call list (→ page 105).

Alternatively you can select a phonebook or call list without using the **Hold** functions - the active call is automatically placed on **Hold**.

Step by step

Alternate?

Switching to the held party (alternating)

Prerequisite: You are conducting a consultation call.

Select and confirm the option shown in the connection's context menu.



It does not matter which context menu is open when alternating. The "Alternate" function appears in both menus (active and passive connection).

You can switch back and forth between two subscribers by repeatedly selecting and confirming "Alternate".

Disconnect?

Ending an alternate operation

Disconnecting the held call:

Select and confirm the option shown in the held connection's context menu.

The held call is disconnected. The active call continues.

Disconnect & return?

Disconnecting the active call:

Select and confirm the option shown in the active connection's context menu.

The active call is disconnected. The held call remains on hold and can be managed via the context menu.

Step by step

Putting on hold and retrieving successively or simultaneously

Putting an active call on hold

Prerequisite: You are conducting a consultation call → page 56 or have accepted a second call → page 86. The "Hold" sensor key must be configured → page 70

 Press the "Hold" key. The key lights up. The consultation or second call **and** the first call are put on hold.

Retrieving the first call



Switch to the first call.



Press the illuminated "Hold" key. You are connected with the other party. The consultation or second call continues on hold.

Retrieving the second call



Switch to the held consultation or second call



Press the illuminated "Hold" key. You are connected with the other party. The first called is put on "Hold" again.

Step by step

Connecting parties

You can connect the first party with the party you consulted, clearing down your connection to both parties in the process.

Prerequisite: You are conducting a consultation call → page 56 and call joining must be allowed → page 59.

Select and confirm the option shown in the active connection's context menu.

The active and held calls are joined. The active call and the consultation call are cleared down.

or



or



Connect by hanging up

Replace the handset or, if you are in speakerphone mode, press the loudspeaker key. The other two parties are now connected to one another.

Allowing call joining

You can also configure this setting via the Web interface → page 195.



Press the key shown.



Select and confirm the option shown.

Select and confirm the option shown.

if nec.



Enter and confirm the User password.

Select and confirm the option shown.

Select and confirm the option shown.



Select and confirm the option shown.



Select and confirm the option shown in the context menu.



Confirm.

Step by step

Call forwarding

You can forward calls for your phone to another phone.



On multi-line telephones (→ page 13), you can only configure call forwarding for the primary line.

Three forwarding conditions can be programmed in the forwarding menu:

- All Calls
- Busy
- On no reply

Because of its direct impact, "All Calls" call forwarding has the highest priority followed by "No reply" and "Busy".

If active, "All Calls" call forwarding is indicated on the graphic display when the phone is idle.

Forwarded calls can be logged in a call list (see → page 35).

The **Edit call forwarding** menu offers you three Destination options. These destination options are assigned to the forwarding types.

All calls (off/on)

Destination

Busy (off/on)

Destination

No reply (off/on)

Destination

One phone number may already be assigned to each destination. The destination option could then be Destination 12345, for instance.

Step by step

Programming call forwarding

Configuring destination phone numbers for call forwarding

You can configure up to five destination phone numbers for call forwarding. These destination phone numbers can then be assigned different forwarding types. You can then enable one of the forwarding types (→ page 63).



Press the key shown.

The pop-up menu opens:

Edit call forwarding

Select and confirm the option shown.

An overview of call forwarding settings appears.



You can also enter the call forwarding settings via the user menu (→ page 80).

Destination

Select the destination option for one of the following forwarding types:

- All calls
- Busy
- No reply

Confirm the destination selected.



You can use each of the three **Destination** options to save destination phone numbers for the relevant forwarding type.

Edit favourites

Select and confirm the option shown in the context menu.

Destination 1

Select and confirm the option shown.



Enter and confirm the destination phone number.

Define additional destination phone numbers for destination 2 to 5, as necessary.

Save & Exit

Select and confirm the option shown.

Step by step



Press the key shown.

The pop-up menu opens:

Edit call forwarding

Select and confirm the option shown.

An overview of call forwarding settings appears.

Destination

Select the destination option for one of the following forwarding types:

- All calls
- Busy
- No reply

Confirm the destination selected.

08972228596

Select and confirm a destination number from the list.

Save & Exit

Select and confirm the option shown.

Defining the ring duration before call forwarding on no reply

You can define how often the phone should ring before the "No reply" form of call forwarding activates.



This setting is only available if the "Server features" function was deactivated by the service personnel.



You can also configure this setting via the Web interface → page 195.

Prerequisite: The phone is idle.



Press the key shown.

The pop-up menu opens:

Edit call forwarding

Select and confirm the option shown.

An overview of call forwarding settings appears.

Duration

Select and confirm the option shown.



Enter a value for the duration.

Save & Exit

Select and confirm the option shown.

Step by step

Activating/deactivating call forwarding

You can also configure this setting via the Web interface → page 195.

Prerequisite: At least one destination phone number is programmed (→ page 62).



Press the key shown.

The pop-up menu opens:

Edit call forwarding

Select and confirm the option shown.

An overview of call forwarding settings appears.

All calls

Select and confirm the option shown.

or

Busy

Select and confirm the option shown.

or

No reply

Select and confirm the option shown.

On

Select and confirm "On" or "Off" in the context menu.

Save & Exit

Select and confirm the option shown.

Step by step

Activating call forwarding for all calls

Use the  function key to activate call forwarding for all calls.



You can also configure this setting via the Web interface → page 195.

Prerequisite: There is at least one forwarding destination programmed → page 61.



Press the key shown.

The pop-up menu opens:

Accept

Select and confirm the option shown. The  key lights up. Call forwarding is activated.

If the phone is idle, the call forwarding icon  appears on the graphic display with the destination phone number.

Deactivating call forwarding for all calls



Press the lit key.

The pop-up menu opens:

The pop-up menu disappears after around five seconds and the  key goes out.

or

Accept

Select and confirm the option shown. Call forwarding is deactivated.

Step by step**Call forwarding chain**

Sometimes calls to a station are forwarded to another station which also has call forwarding or DND activated. This can create a call forwarding chain consisting of several telephones where the last member of the chain is your phone.

A popup window opens on your phone's screen with the following information:

- Who is calling
- Who forwarded first or last.
- The reason for the forwarding is displayed by an icon.

You can set whether the station that forwarded first or last is displayed (see → page 81).

Step by step

Callback

You can request a callback if the station called is busy or if nobody answers.

You receive a callback when the other party's line becomes free.



This option must be activated by your service personnel.



On multi-line telephones → page 13, only the callback requests for your primary line are logged.

Requesting callback

Prerequisite: The station called is busy or nobody answers.

In the pop-up menu:

Call back?

Select and confirm the option shown.

Deleting callback requests

You can delete scheduled callback requests if you no longer need to return a call, for example, at the end of the working day.

Prerequisite: At least one callback was requested.

Cancel call backs?

Select and confirm the option shown in the idle display (→ page 28) context menu.

Disconnect? ▲

Confirm in the pop-up menu. All callback requests are deleted.

Step by step



Responding to a callback

Prerequisite: A callback was requested. Your phone rings and station information appears on the graphic display.

The pop-up menu opens:

Accepting a callback

Select and confirm the option shown.

Rejecting a callback

Select and confirm the option shown.

The callback request is deleted. The caller hears the busy signal. The caller's phone number is added to the missed calls list.

Forwarding a callback

Select and confirm the option shown.

Enter and confirm the phone number.

Step by step



You can also configure this setting via the Web interface
→ page 195.



Press the key shown.

Settings

Select and confirm the option shown.

User

Select and confirm the option shown.

if nec.

Enter and confirm the User password.

Configuration

Select and confirm the option shown.

Outgoing calls

Select and confirm the option shown.

Callback: busy

Select and confirm the option shown.

or

Callback: no reply

Select and confirm the option shown.

Yes

Select and confirm the option shown in the context menu.

Save & Exit

Select and confirm the option shown.

Permitting callback on busy/no reply

Step by step

Calling back missed calls

Calls received while you are absent are indicated by a message on the idle display (→ page 27). The  function key also lights up.

Missed calls are logged in the missed calls list. This list provides information on the missed call and lets you call back the number directly (call lists, see also → page 35).



On multi-line telephones → page 13, only the calls missed on your primary line are logged.



Press the key shown.

Calls

Select and confirm the option shown.

Niels, Bohr 20.05 10:06

Select and confirm the appropriate list entry. The phone number associated with the list entry is dialed.

If no new calls are listed, the call list menu is offered under **Calls** → page 111.

Step by step

Programmable sensor keys

The phone features a range of functions that can, if required, be stored on programmable sensor keys.

The phone comes with six sensor keys, all of which can be programmed on two separate levels.

The "Shifted" sensor key, which allows you to switch between the two programmable sensor key levels, is pre-assigned. This sensor key should be maintained where possible so you can switch between the two programmable sensor key levels.

The labels for the sensor keys are displayed on the right edge of the display.

The sensor keys can also be programmed via the web-interface (→ page 195).

List of available functions

- | | |
|---------------------------|---------------------------|
| 1. Delete (not assigned.) | 17. Group pickup |
| 2. Selected dialling | 18. Repertory dial |
| 3. Repeat dialling | 19. Feature toggle |
| 4. Forward all calls | 20. Show telephone screen |
| 5. Forward no reply | 21. Mobility |
| 6. Forward busy | 22. Directed pickup |
| 7. Ringer off | 23. Callback |
| 8. Hold | 24. Cancel callbacks |
| 9. Alternate | 25. Consultation |
| 10. Blind transfer call | 26. Call Waiting toggle |
| 11. Transfer call | 27. Immediate ring |
| 12. Deflecting | 28. Preview |
| 13. Shift | 29. Call recording |
| 14. Conference | 30. Start application |
| 15. Headset | 31. Integ. Umleit |
| 16. Do not disturb | 32. Start phonebook |

Step by step

Programming sensor keys



You can also configure this setting via the Web interface → page 195.

Beginning programming

Directly via a sensor key



Hold down the sensor key to which a function should be assigned until the programming prompt is displayed.



If the prompt is not displayed or a programmed function is not executed, then you can only launch key programming via the user menu (ask your service personnel about the current setting).

OK

Confirm to begin programming. The sensor key illuminates continuously.

or

Via the user menu

You can also program keys via the user menu.



Press the key shown.

Settings

Select and confirm the option shown.

User

Select and confirm the option shown.

if nec. 

Enter and confirm the User password.

Phone

Select and confirm the option shown.

Program keys

Select and confirm the option shown. You are prompted to press the key you wish to program.



Press the sensor key you want to program with a function. The sensor key illuminates continuously.

Step by step

Normal

or

Shifted

Do not disturb

Label



Save & Exit

Beginning programming

Select and confirm the option shown to program the first level.

Select and confirm the option shown to program the second level.

Select and confirm the required function in the list (e. g. Do not disturb).

Select and confirm the option shown if you want to change the label on the graphic display.

Enter and confirm the label you want.

Select and confirm the option shown.

Programming enhanced functions

Repertory dial

Hold down the sensor key to which a function should be assigned until the programming prompt is displayed.



If the prompt is not displayed or a programmed function is not executed, then you can only launch key programming via the user menu (ask your service personnel about the current setting).

OK



Normal

Repertory dial

Label



Confirm to begin programming. The sensor key illuminates continuously.

You can also configure this setting via the Web interface → page 195.

Select and confirm the option shown to program the first level for instance.

Select and confirm the function in the context menu.

Select and confirm the option shown if you want to change the label on the graphic display.

Enter and confirm the label you want.

Step by step

Setting



Select and confirm this option to enter a destination phone number.

Enter and confirm a stations's destination phone number.

You can select and insert special characters in the dialing sequence:

- « Clear call
- ~ Make consultation
- » Make normal call
- Pause

The pop-up menu also offers the following functions:

- Move cursor right and left
- Copy
- Paste
- Mode selection
- Cancel
- OK

Save & Exit

Select and confirm the option shown.



The repertory dial can be up to 40 characters long.

Step by step

Feature toggle

Only available for Hunt group functions (→ page 152).

Hold down the sensor key to which a function should be assigned until the programming prompt is displayed.

 If the prompt is not displayed or a programmed function is not executed, then you can only launch key programming via the user menu (ask your service personnel about the current setting).

OK

Confirm to begin programming. The sensor key illuminates continuously.



You can also configure this setting via the Web interface → page 195.

Normal

Select and confirm the option shown to program the first level for instance.

Feature toggle

Select and confirm the function in the context menu.

Label



Select and confirm to change the key labeling.

Enter and confirm the label you want.

Setting



Select and confirm this option to enter a code.

Enter and confirm the code, for example: *96 (contact your service personnel).

Save & Exit

Select and confirm the option shown.

Step by step

Forwarding

 Hold down the sensor key to which a function should be assigned until the programming prompt is displayed.

 If the prompt is not displayed or a programmed function is not executed, then you can only launch key programming via the user menu (ask your service personnel about the current setting).

OK

Confirm to begin programming. The sensor key illuminates continuously.



You can also configure this setting via the Web interface → page 195.

Normal

Select and confirm the option shown to program the first level for instance.

Forward all calls

Select a forwarding type:

- Forward all calls
- Forward no reply
- Forward busy

Select and confirm the function in the context menu.

Label

Select and confirm the option shown if you want to change the label on the graphic display.



Accept or edit the label and confirm.

Setting

Select and confirm this option to enter the forwarding destination.



Enter and confirm the phone number of the forwarding destination.

Save & Exit

Select and confirm the option shown.

Step by step

Using sensor keys

The use of programmed functions depends on the phone's status. The relevant display appears once you have pressed a sensor key.

Example 1: Calling saved number

Prerequisite: The idle menu is displayed on the graphic display.

■ Press the sensor key for a saved number. The connection is set up.

Example 2: Call Waiting toggle Activating/deactivating

You can press a key to activate or deactivate call waiting functionality, even during a call. The prerequisite for this is that a second call is permitted (→ page 88). By default a second call is permitted.



Press the "Call Waiting toggle" sensor key. The sensor key goes out. The second call function is deactivated. The call is rejected or forwarded.

Example 3: Immediate ring

This function allows you to switch the preset delay (→ page 129) on and off for all line keys. By default the delay is set, the key does not illuminate.

■ Press the "Immediate ring" sensor key. The sensor key illuminates. The delay ringtone is disabled. An incoming call rings immediately regardless of what delay time is configured.

Step by step

Resetting sensor keys

You can reset sensor keys you configured to factory settings (see also → page 183).



Settings

Press the key shown.

Select and confirm the option shown.

User

Select and confirm the option shown.

if nec.

Enter and confirm the user password.

Reset

Select and confirm the option shown to switch to the **Reset user data** menu.

Function key data

Select the option shown.

Yes

Select and confirm the option shown in the context menu to delete the content of all sensor keys.

Reset selected user data

Select and confirm "Reset selected user data". The contents of the sensor keys you configured are deleted.



Sensor keys which can only be configured by service personnel remain unchanged

Step by step

Enhanced phone functions

Incoming calls

Accepting calls via the headset

Prerequisite: The headset is connected.



The LED flashes when a call is received. Press the key shown. Conduct call.

Ending the call:



Press the key shown. The LED goes out.

Deflecting a call

Using call deflection

Prerequisite: An incoming call is displayed or signaled.

In the pop-up menu:

Deflect

Select and confirm the option shown.

The call is immediately deflected if a destination phone number is programmed (→ page 79).

or

If you did not set a phone number when programming call deflection, a pop-up menu appears prompting you to enter a destination phone number for call deflection.



Enter and confirm the destination phone number. The call is deflected.

Step by step

**Permitting call deflection**

You can also configure this setting via the Web interface → page 195.



Press the key shown.

Settings

Select and confirm the option shown.

User

Select and confirm the option shown.

if nec.

Enter and confirm the User password.

Configuration

Select and confirm the option shown.

Incoming calls

Select and confirm the option shown.

Deflecting

Select and confirm the option shown.

Allow deflection

Select and confirm the option shown.

Yes

Select and confirm the option shown in the context menu.

Default destination

Select and confirm the option shown.



Enter and confirm the phone number to which the station should be deflected.



Entering a destination phone number is not mandatory when call deflection is active. If you want to deflect an incoming call, you are prompted to enter a destination phone number if there is none stored.

or Deflecting to a DSS number

A call can be deflected to a direct station selection (DSS) subscriber using the DSS key, if the key is configured and the deflect function is activated by your service personnel → page 121.

Deflect to DSS: Yes

Information only, as set by service personnel: Yes or No.

Step by step

Reject

Rejecting a call

You can reject an incoming call.

In the pop-up menu:

Select and confirm the option shown.
The caller hears a busy signal.



If the rejected caller's phone number is transmitted, it is saved in the call list. You can then call this party back at a later time.

Configuring call forwarding



You can also enter the call forwarding settings via the Forwarding key (→ page 61).



Press the key shown.

Settings

Select and confirm the option shown.

User

Select and confirm the option shown.

if nec. 

Enter and confirm the User password.

Configuration

Select and confirm the option shown.

Incoming calls

Select and confirm the option shown.

Forwarding

Select and confirm the option shown.

For a description of the settings, see the chapter "Call forwarding" (→ page 60).

Configuring forwarding

Settings

Select and confirm the option shown.

For a description of the settings, see the chapter "Call forwarding" (→ page 60).

Step by step**Setting alerts**

Use the Call forward alerts menu to enable and disable visual and audible alerts for call forwarding (not possible with the Forwarding key).

Alerts

Select and confirm the option shown.

Visual alerts= No

Select the option shown.

Yes

Select and confirm the option shown in the Yes/No context menu.

or

Audible alerts= No

Select the option shown.

Yes

Select and confirm the option shown in the Yes/No context menu.

or

Forwarding station... Last

Select the option shown.

Display last

Select and confirm **Display last/Display first**

Option = Save & Exit

Select and confirm the option shown.

Step by step

Hold

or



Press the "Hold" key. The key lights up. (The "Hold" sensor key must be configured → page 70.)

Reconnect

or



Press the illuminated "Hold" key. (The "Hold" sensor key must be configured → page 70.)

Placing a call on hold

You can use this function to place an ongoing call on hold, for instance, to prevent the other party overhearing a conversation with a colleague in the same room. The held party hears music on hold if **Music on hold** is active on this party's phone (→ page 85).

Prerequisite: You are conducting a call.

Select and confirm the option shown in the connections's context menu.

Retrieving a held call:

Select and confirm the option shown in the connections's context menu.

Using line keys

On multi-line telephones you can use the line keys to place ongoing calls on hold.



Press the corresponding line key. The line key LED starts flickering. The call is now on hold.

Retrieving a held call:



Press the corresponding line key. The line key LED lights up. The call is retrieved.



The LED display → page 23 or status display on the "Overview" tab → page 30 indicates to other multi-line telephones on which this line is also configured, that the call is on hold. These phones can then pick up the call.

Held call wait status

After placing a call on hold, you can replace the handset and then decide if the call should be retrieved or disconnected.

Step by step

Retrieve held call

or

Disconnect



Settings

User

if nec.

Configuration

Connected calls?

Allow hold rem.?

Yes

Save & Exit

Prerequisite: You placed a call on hold and replaced the handset.

In the pop-up menu:

Select and confirm the option shown to resume the call in speakerphone mode.

Select and confirm the option shown to disconnect the call.

Activating/deactivating the hold reminder tone

You can also configure this setting via the Web interface → page 195.

Press the key shown.

Select and confirm the option shown.

Select and confirm the option shown.

Enter and confirm the User password.

Select and confirm the option shown.

Select and confirm the option shown.

Select and confirm the option shown.

Select and confirm the option shown in the context menu.

Select and confirm the option shown.

Step by step

Setting the hold reminder time

Use the "Hold reminder" function to set the length of the timeout before an automatic reminder is issued about a held call.

The minimum value is 1, that is, the reminder is output after one minute. The maximum value is 15 minutes.



You can also configure this setting via the Web interface → page 195.



Press the key shown.

Settings

Select and confirm the option shown.

User

Select and confirm the option shown.

if nec. 

Enter and confirm the User password.

Configuration

Select and confirm the option shown.

Connected calls?

Select and confirm the option shown.

Hold rem. delay

Select and confirm the option shown.



Enter a value between 3 and 15 and confirm.

Save & Exit

Select and confirm the option shown.

Step by step

Music on hold

Music on hold is played back when you are placed on hold by another party, providing this option is active.



You can also configure this setting via the Web interface
→ page 195.



Press the key shown.

Settings

Select and confirm the option shown.

User

Select and confirm the option shown.

if nec.



Enter and confirm the User password.

Configuration

Select and confirm the option shown.

Connected calls

Select and confirm the option shown.

Music on hold

Select and confirm the option shown.

Yes

Select and confirm the option shown in the context menu.

Save & Exit

Select and confirm the option shown.

Step by step

Call waiting (second call)

You can accept a second incoming call in the course of an ongoing call. The caller hears the on-hook signal while you hear a call-waiting signal tone.

You can ignore or accept the second call. Before you accept the second call, you can end the first call or place it on hold for subsequent retrieval.

You can block the second call or the signal tone (→ page 88).

Accepting a second call

Prerequisite: You are conducting a call and call waiting is allowed (→ page 88).

In the pop-up menu:

Select and confirm the option shown.

You can talk to the second party.
The connection to the first party is on hold.

You can still

- toggle between an initial and second call or
- put on hold and retrieve second and first call successively → page 58
or
- initiate a conference

Consultation call from second call

If the second call is your active call you can initiate a consultation call from it.

From a consultation call in the second call you can

- initiate a conference
- toggle between the second call and a consultation call
- put on hold and retrieve second and first call successively → page 58
- transfer a call
- disconnect the calls again

During a consultation in the second call, the first call is parked and can only be unparked when the consultation or second call ends or these calls were connected.

Select and confirm the option shown in the second call's context menu. The call to this station is disconnected and the call to the first station is reconnected.

Accept

Disconnect & return

Step by step

Ignore

Ignoring second call

Prerequisite: You are conducting a call and call waiting is allowed (→ page 88).

In the pop-up menu:

Select and confirm the option shown. The caller still hears the on-hook signal. You can subsequently Accept, Reject or Deflect the second call.

While the ignored second call continues to wait, from the active call you can:

- make a consultation call
- initiate a conference
- toggle between the consultation call and your call party
- transfer a call

A third call would be rejected with the busy signal

If you have disconnected the first call, the ignored second call rings like a normal call.

Rejecting a second call

Prerequisite: You are conducting a call and call waiting is allowed (→ page 88).

In the pop-up menu:

Reject

Select and confirm the option shown.

The second call is rejected. The caller hears the busy signal. The caller's phone number is added to the missed calls list.

Deflecting a second call

Prerequisite: You are conducting a call and call waiting is allowed (→ page 88).

In the pop-up menu:

Deflect

Select and confirm the option shown.



Enter and confirm the phone number.

The second call is deflected to the destination specified. You are reconnected with the first party.

Step by step

Complete Xfer

or **Connect by hanging up**

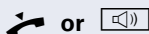

Connecting parties

Select and confirm the option shown in the active connection's context menu. The other two parties are now connected to one another. You can now hang up or dial another number for instance.

Prerequisite: Connecting by hanging up is activated (ask your service personnel) and "Switch assignment" must be set to "Yes" (→ page 89). Before you can be connected by hanging up you must have toggled at least twice (→ page 57).

Replace the handset or, if you are in speakerphone mode, press the loudspeaker key. The other two parties are now connected to one another.

Allowing call waiting



If the Call waiting (second call) function is deactivated, a caller hears the busy signal if you are already conducting a call.

Prerequisite: The option was programmed by your service personnel.



You can also configure this setting via the Web interface → page 195.



Press the key shown.

Settings

Select and confirm the option shown.

User

Select and confirm the option shown.

if nec.

Enter and confirm the User password.

Configuration

Select and confirm the option shown.

Incoming calls

Select and confirm the option shown.

Handling

Select and confirm the option shown.

Allow call waiting

Select and confirm the option shown.

Yes

Select and confirm the option shown.

Step by step

Save & Exit

Select and confirm the option shown.

Assuming **Allow call waiting** is generally activated, you can toggle the configured sensor key to switch call waiting on/off (→ page 88).

Toggling associate

Set the "Toggle associate" function to Yes if you want to connect to a second or pickup call by hanging up.



You can also configure this setting via the Web interface → page 195.



Press the key shown.

Settings

Select and confirm the option shown.

User

Select and confirm the option shown.

if nec.

Enter and confirm the User password.

Configuration

Select and confirm the option shown.

Connected calls

Select and confirm the option shown.

Toggling associate

Select and confirm the option shown.

Yes

Select and confirm the option shown in the context menu.

Save & Exit

Select and confirm the option shown.

Step by step

Blind transfer



Transferring a call

You can transfer your current call to another party with or without consultation.

Blind transfer

Prerequisite: You are conducting a call. The options "Allow call transfer" and "Transfer on ring" were allowed (→ page 91).

Select and confirm the option shown in the connections's context menu.

Enter and confirm the phone number of the second party to whom you want to transfer the call.



The graphic display returns to idle following successful transfer.

Consultation



Transferring with consultation

You can announce a call to a recipient before transferring it.

Prerequisite: You are conducting a call. The options "Allow call transfer" and "Transfer on ring" were allowed (→ page 91).

Select and confirm the option shown in the connections's context menu. The call is placed on hold.

Enter the phone number of the party to whom you want to transfer the call.

Dial

Confirm.

If the party answers:

Announce the call you want to transfer.

Complete Xfer

Select and confirm the option shown in the connections's context menu.

If the party does not answer:

You do not have to wait for the second party to answer before you can transfer the call.

Complete transfer

Select and confirm the option shown in the connections's context menu.

or

Replace the handset or, if speakerphone mode is active, press the lit  key to transfer the call.

Step by step

If the party does not answer, you will be called back by the first party.

Allowing call transfer

You can also configure this setting via the Web interface → page 195.



Press the key shown.



Settings

Select and confirm the option shown.

User

Select and confirm the option shown.

if nec.



Enter and confirm the User password.

Configuration

Select and confirm the option shown.

Connected calls

Select and confirm the option shown.

Allow call transfer

Select and confirm the option shown.

Yes

Select and confirm the option shown in the context menu.

Save & Exit

Select and confirm the option shown.

Step by step

Allowing "Transfer on Ring"

If this option is allowed, you can activate call transfer by replacing the handset even before the called party answers.



You can also configure this setting via the Web interface → page 195.



Press the key shown.

Settings

Select and confirm the option shown.

User

Select and confirm the option shown.

if nec. A small icon representing a keypad, showing a grid of keys.

Enter and confirm the User password.

Configuration

Select and confirm the option shown.

Outgoing calls

Select and confirm the option shown.

Transfer on ring

Select and confirm the option shown.

Yes

Select and confirm the option shown in the context menu.

Save & Exit

Select and confirm the option shown.

Step by step

CTI calls

Beep on auto-answer

Speakerphone mode activates automatically on your phone if you use a CTI application (such as Outlook) to dial a number when Auto Answer is active. If Auto Answer is not active, the phone rings first and you have to press the loudspeaker key or lift the handset to set up the call. This setting also defines whether or not incoming calls are automatically accepted. If the function is active, an alert beep sounds when an incoming call is automatically accepted.

Information on the operation of the configured CTI application can be found in the corresponding user guide.



You can also configure this setting via the Web interface → page 195.

Prerequisite: The option was programmed by your service personnel.



Press the key shown.

Settings

Select and confirm the option shown.

User

Select and confirm the option shown.

if nec. 

Enter and confirm the User password.

Configuration

Select and confirm the option shown.

Incoming calls

Select and confirm the option shown.

CTI calls

Select and confirm the option shown.

Auto-answer

Select and confirm the option shown.

Yes

Select and confirm the option shown.

Beep on auto-answer

Select and confirm the option shown.

Yes

Select and confirm the option shown.

Save & Exit

Select and confirm the option shown.

Step by step

Beep on auto-reconnect

You can reconnect a held call both via the CTI application and via the phone. A beep sounds when you toggle between an active call and a held call when the function is active.

Prerequisite: The option was programmed by your service personnel.



You can also configure this setting via the Web interface → page 195.



Press the key shown.

Settings

Select and confirm the option shown.

User

Select and confirm the option shown.

if nec. 

Enter and confirm the User password.

Configuration

Select and confirm the option shown.

Incoming calls

Select and confirm the option shown.

CTI calls

Select and confirm the option shown.

Beep on auto-unhold

Select and confirm the option shown.

Yes

Select and confirm the option shown.

Save & Exit

Select and confirm the option shown.

Step by step

Making calls

If you want to dial a call from a phonebook or a call list, you should not lift the handset or press the loudspeaker or headset key before.

Dialing with the DDS key

You can program frequently used phone numbers on programmable keys (→ page 70). If you press a DSS key, the associated contact or phone number appears and dialing is initiated.

Prerequisite: A direct destination key is programmed → page 70.

 Press the programmed DDS key. Dialing is initiated.

Dialing from the local phonebook

 Press the key shown.

Personal

Confirm.

or

 Press the configured sensor key "Personal" for the local phonebook (→ page 70).

Niels, Bohr

Select and confirm the entry you want. The phone number is dialed.

Extensive information on the local phonebook and on searching for stations can be found from → page 105.

Dialing from the LDAP database

Prerequisite: You searched for and selected an entry in the LDAP database (→ page 108).

Select the entry you want.

Niels, Bohr

Select and confirm the option shown in the context menu. The connection is set up.

Dial

Step by step

Dialing a phone number from a list

The following call lists are available in the "Calls" directory:

- Missed
- Dialed
- Received
- Forwarded



For a detailed description of the call lists, see → page 35.



Press the key shown.

Calls

Select and confirm the option shown.

Dialed

Select and confirm the required call list.

Niels, Bohr

07:06am

Select and confirm the entry you want. The phone number associated with the list entry is dialed.

Step by step

Using autodial delay

A number is automatically dialed after a set delay starting from the entry of the number's last digit. The autodial delay can be used:

- when dialing in idle mode
- when deflecting an incoming call
- Consultation
- when transferring an answered call.

The delay can be reduced by performing one of the following activities:



- Press the key shown. This always works.



- Lift the handset (off-hook). This only works if the phone number was entered when the phone was idle or if it was entered for a consultation call when the handset was off hook.



- Press the key shown. This only works if the phone number was entered when the phone was idle and the loudspeaker key was not lit or if the phone number was entered for a consultation call and the loudspeaker key was not lit.



If an emergency number is preset by your service personnel, the autodial delay for this phone number is reduced to one second.



Automatic dial delay does not work if you are using a dial plan and **Immediate dialing** is configured (see → page 53). The number is automatically dialed as soon as the string entered matches an entry in the dial plan.

Step by step

Settings for autodial delay



You can also configure this setting via the Web interface → page 195.



The setting does not affect automatic emergency number dialing.

If you select **Autodial delay**, you must either confirm the "Dial" option, press the loudspeaker key or wait until the autodial delay expires to set up a call when dialing with the handset on hook.



Press the key shown.

Settings

Select and confirm the option shown.

User

Select and confirm the option shown.

if nec.

Enter and confirm the User password.

Configuration

Select and confirm the option shown.

Outgoing calls

Select and confirm the option shown.

Autodial delay

Select and confirm the option shown.



Specify a value and confirm your entry.

Save & Exit

Select and confirm the option shown.

Step by step

Allowing "Busy When Dialling"

If you activate this function, an incoming call received while you are performing dialling is rejected. The caller then hears the busy signal.



You can also configure this setting via the Web interface → page 195.



Press the key shown.

Settings

Select and confirm the option shown.

User

Select and confirm the option shown.

if nec. 

Enter and confirm the User password.

Configuration

Select and confirm the option shown.

Outgoing calls

Select and confirm the option shown.

Busy when dialling

Select and confirm the option shown.

Yes

Select and confirm the option shown in the context menu.

Save & Exit

Select and confirm the option shown.



This setup option can also be found under "Handling" in the "Incoming calls" menu.

Step by step

Conference?

User

Disconnect



Conference

Local conference

This type of conference is also referred to as a three-party conference. It involves up to three participants.

Prerequisite: You are conducting a consultation call → page 56 or have accepted a second call → page 86, and the conference function is active → page 101.

Initiating a local conference



You can initiate a conference by calling the "Conference" function in the context menu of either the active or held call. Alternatively you can press an already configured **Conference** key.

Select and confirm the option shown in the connection's context menu. You are connected to both parties at once.

Conducting one-on-one calls

Select the connection you want to clear down on the display.

Select and confirm the option shown in the context menu. You are now involved in a one-to-one call with the remaining call party.



If you already are involved in a secure connection with a party when you initiate a consultation call, the original party is placed on hold. The new consultation connection can be either secure or non-secure. However, the first connection remains secure even if all three parties are now joined together in a conference.

The entire conference is nonsecure if the connection to at least one of the parties is not secure (see also → page 40).

The relevant padlock icon appears on the "Conference" row.

Step by step

Exit Conf?

or



or



End Conf?



Settings

User

if nec.



Configuration

Connected calls

Allow conferences

Yes

Save & Exit

Exiting a local conference

Prerequisite: The function "Allow joining in a local conference" (→ page 102) was activated.

Select and confirm the option shown in the "Conference" context menu. You exit the conference. The other call partners remain connected.

Lift the handset or press the loudspeaker key. Both call partners remain connected. You are disconnected from the conference call.

Ending a local conference

Select and confirm any of the connections in the context menu. Both connections are cleared down – the conference is cleared down.

Allowing a local conference

This option allows or blocks the "Conference" function.

You can also configure this setting via the Web interface → page 195.

Press the key shown.

Select and confirm the option shown.

Select and confirm the option shown.

Enter and confirm the User password.

Select and confirm the option shown.

Select and confirm the option shown.

Select and confirm the option shown.

Select and confirm the option shown in the context menu.

Select and confirm the option shown.

Step by step

Allowing joining in a local conference

You can use this option to decide whether or not your call partners are allowed to join calls after you exit the conference call.



You can also configure this setting via the Web interface → page 195.



Press the key shown.

Settings

Select and confirm the option shown.

User

Select and confirm the option shown.

if nec. A small icon representing a keypad, consisting of a 3x3 grid of squares with a small circle at the bottom right.

Enter and confirm the User password.

Configuration

Select and confirm the option shown.

Connected calls

Select and confirm the option shown.

Join in conferences

Select and confirm the option shown.

Yes

Select and confirm the option shown in the context menu.

Save & Exit

Select and confirm the option shown.

Step by step

Conference?

System-based conference

This type of conference is also referred to as a large conference. It can include up to ten parties.

Prerequisite: You are conducting a consultation call → page 56 or you have accepted a second call → page 86, and the "System conference" feature was configured by your service personnel.

Establishing a conference

Select and confirm the option shown in the connection's context menu. You are connected to the first two parties at once. The conference is displayed with the current participants. You can now:

- initiate a consultation call
- add a party
- put the conference on hold
- leave the conference.

Conducting a consultation call

Select and confirm the option shown in the "Conference" context menu. If the party answers, you can:

- toggle between the party and the conference
- connect the consultation call to another called party
- end the consultation call and return to the conference
- add the consultation call party to the conference.



If you intend to include the consultation call party in the conference, you can also use the "Hinzufügen zu Konferenz" option instead of the "Consultation" option.

If you want to use the **phonebook** or a **call list** for the consultation, select **Hold** in the context menu instead of Consult (or Hinzufügen zu Konferenz) or press the **Hold** key and then select the phonebook or a required call list (→ page 105).

Alternatively you can select the phonebook or a call list without using the **Hold** functions - the conference call is automatically placed on **Hold**.

Consultation?

Add party

Prerequisite: You are conducting a consultation call and the conference is on hold.

Step by step

Conference?

Select and confirm the option shown in the consultation call's context menu. The party is added to the conference. Only the conference and all current participants are now displayed.



You can also use an already configured **Conference** key instead of the Conference option in the context menu.

Hold?

Select and confirm the option shown in the "Conference" context menu. The conference is placed on hold and you can consult with someone in your office, for instance.

Exit Conf?

Leaving a conference

Select and confirm the option shown in the "Conference" context menu. You are disconnected from the conference call and can dial another number, for instance. The other call partners remain connected.

Step by step

Phonebooks and call lists

Local phonebook

The personal phonebook is restricted to 100 entries. If you have configured a sensor key for the local phonebook, you can open it using this sensor key (→ page 70).



If you are signed on as a mobility user (→ page 140), you cannot use the phonebooks as entries are not saved when you sign off.

Creating a new contact

You can also create contacts via the web interface → page 195.



Personal

Press the key shown.

Confirm to open the local phonebook.

Option

Select the option shown.

New contact

Confirm the option shown in the context menu.



Fill in the three fields

- Last name
- First name
- Number

accordingly.

Save & Exit

Select and confirm to save the phonebook entry.

Editing a contact

You can also edit contacts via the web interface → page 195.



Personal

Press the key shown.

Confirm to open the local phonebook.

Niels, Bohr

Select the required entry.

Step by step

Details

Select and confirm the option shown in the context menu.

Last name

Select and confirm, for example the Last name field.



Change and confirm .

Save & Exit

Select and confirm the option shown.

Deleting a contact

You can also delete contacts via the web interface → page 195.



Press the key shown.

Personal

Confirm to open the local phonebook.

Niels, Bohr

Select the required entry.

Delete

Select and confirm the option shown in the context menu. Then confirm the Delete or cancel the process.

Deleting all contacts

You can also delete the contacts via the web interface → page 195.



Press the key shown.

Personal

Confirm to open the local phonebook.

Option

Is displayed

Delete all

Select and confirm the option shown in the context menu.

Step by step



Personal

Option



Kirsch, Erika

Kramer, Elisabeth

Searching for a contact

Press the key shown.

Confirm to open the local phonebook.

Is displayed

Enter the first letter of the name you are searching, e.g. k.



The name first found in which the first letter is K is displayed. If you are looking for a name that begins with Kr, also enter the second letter in the search field:

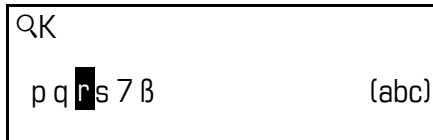

The first name with the initial letters Kr is displayed.

You can also browse the phonebook with the **navigator** until you reach the required station. → page 20.

Step by step

LDAP database

You can search an LDAP database (corporate phonebook) for contact entries if you can reach this database over your network and your access was correctly configured by your service personnel.

You can search for the name (simple search) or for different entry information (advanced search) e. g. search for the job or department name.

Finding an LDAP entry



Press the key shown.

Corporate

Select and confirm to open the company-wide Phone book "Corporate".

Find

Select and confirm the option shown in the **Options** context menu

Last name

Select and confirm the required search field (for example, "Last name").



Enter a search text. If you for example only enter the first letter of the last name, all entries with this initial letter are displayed.

Find

Select and confirm when you have filled out one or more search fields. The search begins. If the entry you searched for is found, you can dial or view the entry details.

Step by step

Details

Delete

Qualifier

Extended LDAP editing

Viewing an LDAP entry

Prerequisite: You found and selected an LDAP entry (see above).

Select and confirm the option shown in the context menu for the entry. All fields of the entry are displayed.

Resetting the search fields

Prerequisite: The search fields are listed.

Select and confirm the option shown in the **Options** context menu. You can now enter the search criteria for the search.

Defining a qualifier before a search

Prior to a search, you can select which qualifiers should also appear in the output list in the **Options** context menu.

Select and confirm the option shown. You may choose between the following criteria:

- No qualifier
- Job function
- Address 1
- Email
- Business 1
- Mobile
- Business 2
- Private
- Company
- Address 2



Select and confirm the desired qualifier.



Exit the list.

Step by step



Corporate

Option



Kirsch, Erika

Quick search

Press the key shown.

Select and confirm to open the company-wide Phone book.

Is displayed

Enter the first letter of the name you are looking for, e.g. "k".



Do not enter any further characters. After a predefined period of time or after pressing the key all available names with the corresponding initial letter are displayed.

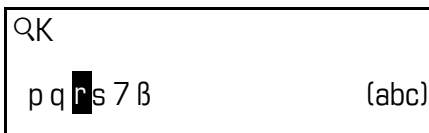

You can restrict the output by entering the second and other letters. The key is used to switch between letters and numbers. The key is used to delete individual characters.

When entering extended characters you can control the search individually. For the selection of extended characters firstly press the key.

Rule list:

Character	Description
#	Searches for the exact string before the extended character
,	You can enter first and last name separately using a comma. A search is carried out for the last name (possibly using a wildcard) and the first name with the first character after the comma.
*	Wildcard. This searches for the character entered and all possible subsequent characters

Step by step

Call lists

For a detailed description of the different call lists, see → page 35.

Editing entries

Selecting an entry

Press the key shown.

Select and confirm the option shown.

For instance, select and confirm the list of missed calls → page 69).

The list is sorted chronologically, with the most recent caller first.

You can use the **navigator** to scroll through the list.

Select the list entry.

Displaying details

Select and confirm the option shown in the context menu.

For display and information shown.

Delete the entry

Select and confirm the option shown in the context menu.

The entry is deleted.

Delete all entries

Press the key shown.

Select and confirm the option shown.

For instance, select and confirm the list of dialed numbers.

Select the option shown.

Select and confirm the option shown in the context menu.

All entries in the list displayed are deleted.



Calls

Missed

Niels, Bohr 22.05 13:22

Details

Delete



Calls

Dialed

Options

Delete All

Step by step

Making calls with multiple lines

You can use your OpenStage 40 as a multi-line phone. If you have any questions regarding how to configure your OpenStage phone as a multi-line phone, please contact your service personnel.

The following is a description of the telephony scenarios for multi-line phones. To facilitate comprehension, you should familiarize yourself with the enhanced telephony application and how to use the line keys beforehand. Furthermore, you can specify individual settings for your multi-line telephone. Refer to the following sections for a detailed description of the individual components:

- Introduction to multi-line phones → page 13
- Lines and line keys → page 22
- Multi-line telephony interface → page 30
- Individual settings → page 128

Incoming calls

Depending on your individual settings, you will be notified of incoming calls → page 171.

Accepting calls for the primary line

In this case, the telephone behaves in the same way as a single-line telephone. See → page 40 and → page 78.

Accepting calls for secondary lines

Prerequisite: The secondary line is configured on your multi-line telephone.

Using the handset



Lift the handset.



Conduct call.



The line used for the ringtone is selected automatically. If there are calls on several lines, you are connected with the line that has been ringing the longest.

Step by step



Accept

Using the line keys

Press the flashing line key.

Speakerphone mode.

Select and confirm the option shown.

Speakerphone mode.

Making calls

You must seize a line before you can make calls on a multi-line telephone.

Trunk seizure can be configured on an individual basis. Your service personnel can determine if the lines on your telephone can be automatically seized and with which priority.



If you have seized a secondary line, this line is reserved for you for making calls for a specific period as defined by the service personnel. No other user can seize this line during this period, even if the line is also assigned to this user's telephone.

Manual trunk seizure



Lift the handset or press the speakerphone mode or headset key.



or



Press the required line key.

Press the key shown to open the **Overview** tab
→ page 30.

Line 2

Select and confirm the required line (e.g. line 2). The selected line is displayed on the screen.

Enter the phone number or use redial, for example. The connection is set up.

Step by step

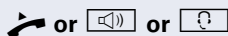

Automatic trunk seizure

Prerequisite: Your service personnel has configured automatic trunk seizure.

Lift the handset or press the speakerphone mode or headset key.



The line defined during configuration is seized.



Enter the station number. The connection is set up.

Dialing the last dialed number

Regardless of the line used, the last number dialed on your telephone is displayed for redialing in the selected number's context menu.



Lift the handset or press the speakerphone mode or headset key.



Press the required line key (→ page 113).

In the pop-up menu:

Redial {1} 12345

Confirm. The connection is set up.

Forwarding calls on primary line

The call forwarding can only be activated for the primary line. Which call forwards are possible, how they are configured and activated can be found from → page 60.

Call forwarding information

Prerequisite: Your service personnel has activated "Forwarding shown".

If you have activated one of the forwarding types on your phone for the primary line and a station calls, a popup window with the following information opens:

- Who is calling
- The forwarding destination.

Step by step

During calls

Making and receiving calls on a single line

If you only use one line on your multi-line telephone to make calls, and you receive calls on the same line, the phone operates in the same way as a single-line telephone:

- Redial → page 55
- Consultation → page 56
- Alternate → page 57
- Callback → page 66
- Hold → page 82
- Call waiting (second call) → page 86
- Transferring a call → page 90
- Conference → page 100

Functions available exclusively for the primary line:

- Call lists → page 35
- Voicemail → page 34
- Call forwarding → page 60
- Do not disturb → page 134

 Depending on your individual settings, you will be notified of incoming calls → page 132.

Making and receiving calls with multiple lines

Accepting a waiting call

 Depending on the settings for "Rollover", you will be notified of incoming calls → page 132.

Prerequisite: You are conducting a call. At the same time, a call is incoming on another line.



Call on line 1.



Press the line key for line 2. The call on line 1 is placed on hold.

Step by step



All multi-line users that share the line on which the call is being held (→ page 22) can now pick up the held call. To prevent other users from answering the held call, you must place the call on "Consultation" hold → page 56.

Depending on the setting made by your service personnel, you may have to press the trunk key twice to accept the call on the other line. The first call is either placed on hold or released depending on the setting.



Conduct call on line 2.



End call on line 2.



Press line key for line 1.



Retrieve call on line 1.

Putting a line on hold

On a multiline telephone you can use the line keys to place calls on hold.

Prerequisite: You are conducting a call.



Press the call-line sensor key.



- The LED line key flashes.
- The LED line displays the hold status on all multi-line phones to which the line is connected.
- On phones connected to the line, a user can press the relevant line key and accept the held call.

During a consultation call or after accepting a waiting call the hold function cannot be used.

Step by step

Lines with hot or warm line function

Your service personnel can configure a hot or warm line for the primary and secondary line.

The function is activated when on

- The Primary line
you pick up the phone's handset or press the line or loudspeaker key
- the secondary line
you press the line key.

A number specified by you is dialed with a hot line immediately and with a warm line after a specific time.

Examples:

- The phone in the lift immediately dials the reception number.
- The phone at a patient's bed dials the ward number e.g. after a minute if no other number is dialed.

Entering a number for the hot and warm line function

Specify which number should be dialed when the hot or warm line function is activated.

You can also configure this setting via the Web interface → page 195.



Settings

Press the key shown.
Select and confirm the option shown.

User

Select and confirm the option shown.

if nec.

Enter and confirm the User password.

Configuration

Select and confirm the option shown.

Keypad

Select and confirm the option shown.

Lines

Select and confirm the option shown.

Line

Select and confirm the required line in the context menu.

Hot warm dest = nnnn

Select and confirm the option shown.



Enter and confirm the destination.

Step by step

Save & Exit

Select and confirm the option shown.

Busy override

A station of a line trunk group is on a call. It's primary line is configured as a secondary line on your phone. This line now has the status "busy." You can join in the call by pressing the illuminated key of this line (see also → page 22).

Prerequisite: A secondary line is configured on your multiline phone and busy override is enabled for you.

The key of secondary line illuminates – it is busy. You want to join in the call.

Press the lit key. A conference is established. You are connected to the parties on the secondary line. The key continues to illuminate and the conference is shown on the display.



If there is already a conference on the secondary line you are connected to this conference. The conference is shown on the display.

You can now:

- Put the secondary line on hold
- Leave the conference on the secondary line
- Make consultation call
- Accept a second call
- Alternate between a new call party and a conference on the secondary line.
- Include a call party from a consultation or a second call in the conference.

Step by step

Direct station selection keys

Apart from line keys, service personnel can also configure direct station selection (DSS) keys. You can use a DSS key to call an internal station directly, pick up calls for this station or forward calls directly to it.

Calling a station directly

You cannot use DSS if the user is on another call (flashing LED).

Calling from the idle menu



Press the relevant DSS key.

Press the key shown to open the **Overview** tab
→ page 30.

DSS call 1

Select and confirm the DSS line. The key lights up and a connection is established.



Service personnel can configure the DSS key so that the connection is also established when the DSS station has activated do-not-disturb or call forwarding.

Consultation with the DSS station

Prerequisite: You are conducting a call and service personnel have configured the DSS key for consultation.



Press the relevant DSS key for the consultation. The key lights up and a connection is established. If the station answers, you can toggle, transfer the first call or initiate a conference.



If service personnel have configured transfer instead of consultation, you can only transfer the current call to the DSS station.

Step by step

Call pickup

You can pick up calls for another DSS station. If a call is waiting on their line, the LED flashes.

Indirect pickup

Prerequisite: The auto-answer function must be deactivated → page 93.



Press the DSS key. The call is routed to your primary line and rings.



Lift the handset or press the speakerphone mode or headset key. You are connected with the other party.

Rejecting a call

Prerequisite: Service personnel must activate the reject option for DSS keys and auto-answer must be deactivated → page 93.



Press the DSS key. The call is routed to your primary line and rings.

Reject

Select and confirm the option shown in the pop-up menu.
The caller hears a busy signal.

Direct pickup

Prerequisite: The auto-answer function must be activated → page 93.



Press the DSS key. The call is routed to your primary line and you are immediately connected with the other party via speakerphone.

Deflecting a call to a DSS station

Prerequisite: The deflect function must be approved for DSS keys. For information on the current setting, see → page 79.

If you receive a call on one of your lines, you can immediately deflect it to the DSS station.





Your phone rings and a line key flashes.



Press the relevant DSS key. The call is deflected to the DSS station. If the DSS station does not answer, you can pick up the call by pressing the DSS key.

LED display on DSS keys

DSS Key	Explanation
	Off: The line is in idle mode.
	Flashes: You can accept a call for the DSS station via the key. The call is routed to your primary line when the call is accepted.
	Illuminates: The line is busy. Provided that second call is activated you can still reach the DSS station via the key. It can accept your call as a second call.

Step by step

Making calls in an executive-secretary team

An executive-secretary team is configured by the relevant service personnel and may include up to four executive and up to two secretary telephones.

Sample scenarios

This example assumes that two executive and two secretary phones are configured. Calls for the executives are forwarded immediately to the respective secretary phone. A secretary then connects the call with or without consultation to the responsible executive using the direct station selection key.

Secretary 1



Secretary 2



Executive 1



Executive 2



Prerequisites:

The following call forwards are configured (→ page 60):

- For All calls from Executive 1 to Secretary 1
- For All calls from Executive 2 to Secretary 2
- Forward on Busy and forward on No reply from Secretary 1 to Secretary 2
- Forward on Busy and forward on No reply from Secretary 2 to Secretary 1

"Allow call waiting" should be activated on the secretaries' phones (→ page 88). This function can optionally be activated and deactivated using a key if a key has been configured for it.

Step by step

Line and direct station selection keys have been configured by service personnel and "Transfer on hangup" and server features have been activated.

Step by step

Accepting a call

Incoming calls for the executives should be forwarded immediately to the assigned secretary and answered there. The line overview (→ page 127) shows whether the executive has activated call forwarding.

Accepting calls at the secretary phone

An incoming call for "Executive 1" rings at the assigned "Secretary 1".

The line key of the "Secretary 1" phone flashes.



The "Secretary 1" direct station selection key on the "Executive 1" phone also flashes.



Press the line key to answer the call. The station answers. The line key flashes **rapidly**.



The "Secretary 1" direct station selection key on the "Executive 1" phone illuminates.

Early call pickup by Executive 1

An incoming call for "Executive 1" rings on "Secretary 1". The "Secretary 1" direct station selection key on the "Executive 1" phone flashes. The "Secretary 1" has not yet answered the call. Before the call is forwarded to "Secretary 2", "Executive 1" picks up the call early.



Press the "Secretary 1" direct station selection key on the "Executive 1" key to answer the call.



If for example a call for "Executive 2" on "Secretary 2" is not answered, "Secretary 1" or "Executive 1" can pick up the call early

Step by step

Forward to Secretary 2

An incoming call for "Executive 1" rings at the assigned „Secretary 1“. The call is **not** answered. After a specified period the call is forwarded to "Secretary 2". The line key of the "Secretary 2" flashes and it rings.



Press the line key on the "Secretary 2" phone to answer the call. The station answers. The "Secretary 2" direct station selection key on the "Executive 1" phone illuminates.



If "Secretary 1" is busy, the call is forwarded immediately to "Secretary 2" if:

- a consultation call is being made or
- "Allow call waiting" is deactivated.

Second call

If "Secretary 1" receives a second call, this can be accepted, ignored, forwarded or rejected. Detailed information on this can be found from → page 86.

If the second call is ignored, it is forwarded to "Secretary 2" after a certain period of time.

If the second call was answered, it can be forwarded using consultation or the direct station selection keys.

Connecting a call

If e. g. the "Secretary 1" answered a call, it can forward the call using the direct station selection keys to the following telephones:

- Executive 1
- Executive 2
- Secretary 2.

The following examples show connections to "Executive 1".

Step by step



Connecting with consultation

Press the DSS "Executive 1" key. "Executive 1" answers. Announce the call.

Press the hang-up, loudspeaker or headset key.



You can also select "Complete Xfer" from the context menu.

Complete transfer



Connecting without consultation

Press the DSS "Executive 1" key. "Executive 1" does not answer.

Select and confirm the option shown in the pop-up menu.

Press the hang-up, loudspeaker or headset key. The "Executive 1" phone rings.

If "Executive 1" does not answer the call, a callback (see also → page 90) will ensue after a configured time.



The "Executive 1" direct station selection key on the "Secretary 1" phone illuminates.

Disconnect & return



Consultation without connecting

Press the DSS "Executive 1" key. "Executive 1" answers. Transferring is not wanted. The "Secretary 1" takes the call back.

Select and confirm the option shown in the pop-up menu. The "Secretary 1" is reconnected with the caller.

Toggle, disconnect or conference

During a consultation call "Secretary 1" can toggle between "Executive 1" and the caller, can initiate a conference or disconnect one of the two call parties. More on this subject can be found on pages → page 57 and → page 100.

Step by step

DSS keys can be used

These keys are configured in such a way that every phone can be reached by every phone in the group. The DSS keys are also used for consultation calls.

- Press a team member’s DSS key. The relevant phone rings and the party answers.

Using line overview

To view the status of the lines, change from the "My phone" tab to the "Overview" tab on the phone screen using the ↩ key.

Overview	Line
DSS:Executive 2 Line busy	Executive 1
☎ DSS:Executive 2 Line busy	Executive 2
📞 DSS:Executive 2 Line busy	Secretary 2
DSS:Executive 1 Line forwarded	
	Shift key

Further information on the line status can be found on → page 30.

The "executive-secretary" team can be expanded with line keys by the service personnel. These lines keys however have no influence on the behavior of the "executive-secretary" configuration.

Step by step

Settings for MultiLine (keyset)

The details for each keyset line contain supplementary information for the user. The following uneditable fields are displayed:

- Address
 - Displays the phone number for the line
- Ringtone on/off
 - Shows whether the ringer is activated for this line
- Selection sequence
 - Displays the priority of each line seizure when the handset is lifted or the loudspeaker key for this line is pressed

Displaying the line in the "Overview" tab

Specify here if the selected line should be displayed in the "Overview" tab.



You can also configure this setting via the Web interface → page 195.



Press the key shown.

Settings

Select and confirm the option shown.

User

Select and confirm the option shown.

if nec.

Enter and confirm the User password.

Configuration

Select and confirm the option shown.

Keyset

Select and confirm the option shown.

Lines

Select and confirm the option shown.

Line 1

Select and confirm the required line (for example, line 1).

Allow in overview

Select and confirm the option shown.

Yes

Select and confirm the option shown in the context menu.

Save & Exit

Select and confirm the option shown.

Step by step

Setting the time for a delayed ringer

Specify the length of time before a held call should be signaled on a line.



You can also configure this setting via the Web interface → page 195.



Press the key shown.

Settings

Select and confirm the option shown.

User

Select and confirm the option shown.



Enter and confirm the User password.

Configuration

Select and confirm the option shown.

Keypad

Select and confirm the option shown.

Lines

Select and confirm the option shown.

Line 1

Select and confirm the required line (for example, line 1).

Ring delay

Select and confirm the option shown.



Enter and confirm a delay value.

Save & Exit

Select and confirm the option shown.

You can activate and deactivate the set delay time for all line keys using a function key → page 76.

Step by step

Configuring the "Overview" tab display

Specify here the sequence in which the individual lines in the "Overview" tab should appear on the display.



You can also configure this setting via the Web interface → page 195.



Press the key shown.

Settings

Select and confirm the option shown.

User

Select and confirm the option shown.

if nec.

Enter and confirm the User password.

Configuration

Select and confirm the option shown.

Keyset

Select and confirm the option shown.

Overview

Select and confirm the option shown.

All lines that are displayed in the overview are listed.

Line 1

Select and confirm the required line (for example, line 1).

Select one of the following options from the context menu to move an individual line:

- Move up
- Move down
- Move to top
- Move to bottom

or

Use FPK order

Select and confirm the option shown to arrange the lines in the same sequence as the line keys

or

Add all lines

Select and confirm the option shown to display all line keys in the overview.



The setting made for "Allow in overview" (→ page 128) is disregarded here.

Save & Exit

Select and confirm the option shown.

Step by step

Line preview

Activating via the line keys

Prerequisite: You are already on a call on one line and a further call rings on the secondary line. Service personnel have activated line preview.



Press the flashing line key. A popup window opens and you receive information about the caller.



Press the flashing line key to answer the second call.



If service personnel have deactivated the line preview, a call is answered immediately on a second line when the line key is pressed, without showing caller information.

Activating via preview key

Prerequisite: You have programmed a sensor key with the "Preview" → page 70 . Your service personnel have activated the preview function.

Preview for a call:

You are already conducting a call on one line. A further call rings on a secondary line.



Press the "Preview" sensor key. A popup window opens and you receive information about the caller.



Press the "Preview" sensor key again to hide the preview or wait until the popup closes itself after a specified period of time.

Permanent preview



Press the "Preview" key in idle mode. This way the preview for all lines with "preview mode" remains active until you press the "Preview" sensor key again.

Step by step

Rollover for a line

Your service personnel can determine how rollover calls are to be signaled.



or



You hear a **special advisory tone** via the currently active microphone and the corresponding line key blinks.

or



The **ringer melody set sounds briefly** (approx. 3 seconds) via the loudspeaker and the corresponding line key blinks.

or



You hear a short **notification tone**



The ringer melody is not played in speakerphone mode.



The telephone rings using the configured call signal, the corresponding line key blinks, and a pop-up menu containing the available information is displayed.

Step by step

Privacy/security

Deactivating the ringer

You can deactivate your ring tone if you do not want to be disturbed by your phone ringing.



Hold down the key shown.

The "Ringer off" icon appears in the status bar on the idle display → page 26.



Hold down the key once again to reactivate the ringer. The icon disappears.

You can also switch the function on and off using the option in the idle menu.

Ringer off?

Select and confirm the option shown.

or

Deactivating the ring tone via sensor key

Prerequisite: The "Ringer off" sensor key must be programmed (→ page 70).



Press the "Ringer off" sensor key

An incoming call is signaled by a single ring tone burst.



Press the illuminated sensor key once more to deactivate the "Ringer off" function.

Step by step

Do not disturb

If "Do not disturb" is activated, your telephone will not ring. The caller hears the busy signal.



On multi-line telephones (→ page 13) you can only activate the "Do not disturb" function for your primary line.

Prerequisite: A programmable key is assigned the function "Do Not Disturb" (see → page 70). "Do not disturb" must be activated (→ page 135).

Enabling do not disturb via a key



Press the "Do not disturb" programmable key.



Press the lit programmable key once more to deactivate the "Do not disturb" function.



You can also use the programmable key to activate the "Do not disturb" function during a call or deactivate it when an incoming call is being signaled.

or

Do not disturb on

Select and confirm the option shown in the idle menu. The "Do not disturb" icon appears in the header.

or

Do not disturb off

Select and confirm the option shown in the idle menu. The "Do not disturb" icon is deleted.

Step by step

Allowing "Do not disturb"



You can also configure this setting via the Web interface
→ page 195.



Press the key shown.

Settings

Select and confirm the option shown.

User

Select and confirm the option shown.

if nec. 

Enter and confirm the User password.

Configuration

Select and confirm the option shown.

Incoming calls

Select and confirm the option shown.

Handling

Select and confirm the option shown.

Allow DND

Select and confirm the option shown.

Yes

Select and confirm the option shown.

Save & Exit

Select and confirm the option shown.

Step by step

Security

User password

Your User password protects your individual configurations, including your language settings. You can also use the User password to lock your telephone → page 138.

 The preset password "000000" corresponds to a blank password. In other words, the phone cannot be locked and the user menu is **not** password protected (see also → page 137).



You can also change the user password via the Web interface → page 195.



Press the key shown.

Settings

Select and confirm the option shown.

User

Select and confirm the option shown.

if nec. 

Change and confirm User password.

Security

Select and confirm the option shown.

User password

Select and confirm the option shown.



Specify a new password (at least six characters, text entry, see → page 25) and confirm your entry.

Confirm password

Select and confirm the option shown.



Enter the password again and confirm.

Save & Exit

Select and confirm the option shown.

Step by step

Deactivating the user password

You can deactivate the phone's password prompt if a password has already been configured.

 Deactivating the password prompt does not apply to the web-interface → page 195, Open-Stage Manager or CTI applications that use a password prompt. The password "000000" must be entered here.

If you deactivate the user password, you are **not** able to lock the phone → page 138 and the user menu is **not** password-protected.



Settings

User

if nec. 

Security

User password

if nec. 



Confirm password



Save & Exit

Press the key shown.

Select and confirm the option shown.

Select and confirm the option shown.

Change and confirm User password.

Select and confirm the option shown.

Select and confirm the option shown.

Press the key to delete the existing password.

Enter six zeros ("000000") to deactivate the password (for text input, see → page 25) and confirm.

Select and confirm the option shown.

Enter six zeros ("000000") once again and confirm.

Select and confirm the option shown.

Step by step

Phone locking

You can lock your phone to protect it against unauthorized access. In this way, no one can make calls or change your user settings unless they know your user password.

Predefined numbers from the dial plan can still be dialed when the phone is locked. For more information, contact your administrator.

If an emergency number has been entered on the phone by service personnel, "emergency call" is then offered as an option on the display when the lock is activated. You can also enter the emergency number via the keypad.



You can only lock the phone if you set a user password (→ page 136). The password for this should not match the default "000000".

Activating the phone lock



Hold down the key shown until "Phone lock: Confirm locking the phone" appears.

Confirm lock

Confirm. The phone is locked.

or



Press the key shown.

User

Select and confirm the option shown.



Enter and confirm the User password.

Security

Select and confirm the option shown.

Phone lock

Select and confirm the option shown.

Yes

Select and confirm the option shown.

Save & Exit

Select and confirm the option shown. The phone is locked.

Step by step

Unlock phone



Unlocking the phone

Confirm.

Enter the User password and confirm. The phone is unlocked if the password is correct.



The specified emergency number can be dialed when the phone is locked.

If the telephone is locked, redial keys cannot be used. This also applies if the emergency number is saved on it.

Step by step

Mobility

Prerequisite: Your phone is configured to support mobility by service personnel. A DLS server is available in the LAN and its address is entered in the phone.

Mobility scenarios

When you log on to your phone, or any other mobility-enabled phone, the following scenarios are possible:

Logging on and off at the same phone

- Log on as a mobility user → page 141.
- Log off as a mobility user → page 142.

Logging on and off at different phones

In these cases, service personnel may have made the following settings:

- Log on at a remote phone with forced logon, when the user is still logged on at that phone → page 143.
- Delayed logon at a remote phone with forced logon, when the user is still logged on at that phone and the phone is busy → page 144.

Step by step

Logging on and off at the same phone

Logging on to the phone

No other mobility user is logged on.

Logon via a key

If a sensor key is configured for Mobility .



Press the "Mobility" sensor key.

or

Logon via the context menu

Mobile logon

Select and confirm the option shown in the idle display (→ page 29) context menu.

Mobility ID

The **Mobility logon** dialog appears.

You are prompted to enter your mobility ID.



Enter and confirm Mobility ID, usually a telephone number.

Enter password

You are prompted to enter the password.



Enter and confirm the user password.

The following messages appear on the display:

- Logging on mobile user
- Validating
- Registering
- Downloading user data

Once logon is complete, the "Mobility" program key LED lights up and the mobility icon  appears in the graphic display next to the mobile phone number.

Step by step

Logging off from the phone

Prerequisite: You are logged on as a mobility user.

Logoff via key

If a program key is configured for Mobility.



Press the "Mobility" program key.

or

Logon via the context menu

Mobile logoff

Select and confirm the option shown in the idle display context menu → page 29.

Mobile logoff

Is displayed. You briefly have the option to cancel the logoff, otherwise the logoff process is launched.

In the graphic display, the following messages appear:

- Logging off mobile user
- Uploading user profile
- Registering
- Downloading user data

After you have logged off, the mobility icon  is hidden.

Step by step

Logging on at different telephones

An attempted login is rejected if the user is already logged on to another phone and "Logon with forced logoff" is disabled for the mobility user.

Logging on with forced logoff at a remote phone

If the user is already logged on at another phone and the remote phone is busy, the logon is rejected.

If however, your service personnel enabled "Forced logoff during call" without setting a time, the system does not consider whether or not the remote phone is busy.

Logon via a key

If a program key is configured for Mobility.

 Press the "Mobility" program key.

or Logon via the context menu

Mobile logon

Select and confirm → page 29 the option shown in the idle display context menu.

Mobility ID

You are prompted to enter your mobility ID.



Enter and confirm Mobility ID, usually a telephone number.

Enter password

You are prompted to enter the password.



Enter and confirm the user password.

The following mobility messages appear in the display:

- Validating
- Logging off elsewhere
- Registering
- Downloading user data

The logoff is simultaneously displayed on the remote phone. Once logon is complete, the "Mobility" program key LED lights up and the mobility icon appears in the graphic display .

Step by step

Logging on with forced, delayed logoff at a remote phone

If the remote phone is busy and your service personnel enabled "Forced logoff during call" with a set timeout, forced logoff does not occur until this timeout expires.

Logon via a key

If a program key is configured for Mobility.



Press the "Mobility" program key.

or

Logon via the context menu

Mobile logon

Mobility ID

Enter password



Select and confirm the option shown in the idle display context menu → page 29.

You are prompted to enter your mobility ID.

Enter and confirm Mobility ID, usually a telephone number.

You are prompted to enter the password.



Enter and confirm the user password.

The following mobility messages appear in the display:

- Validating
- Logging off elsewhere



At the same time, the graphic display on the busy remote phone shows "Forced logoff pending". After the set timeout, the active call is ended and remote logoff is performed.

- Registering
- Downloading user data

Once logon is complete, the "Mobility" program key LED lights up and the mobility icon appears in the graphic display .

Step by step

OpenScape Voice functions

The OpenScape Voice supports a number of functions that you can activate and deactivate from your phone.



On multi-line telephones, the full scope of OpenScape Voice functions is only available for the primary line.

Feature toggle key

You can pick a programmable sensor key and program it as a feature toggle key for activating the "make line busy" and "stop hunt" functions.

You can then use the programmable sensor key to activate or deactivate the relevant OpenScape Voice function on the server for this phone.

You can only program first-level programmable sensor keys because those linked to LEDs are used to display function status as either **on** (LED on) or **off** (LED off). The LED indicates the status of the function on the server and can therefore change without any of the programmable sensor keys being pressed.

Example:

Switching between "Line busy" and "Line free" (see also → page 152).

Prerequisite: Your service personnel configured a programmable sensor key with the function "Busy" ("make line busy" for the hunt group) → page 74.



Press the programmable sensor key – the key lights up.



Press the illuminated programmable sensor key once again to release the line - the keys stops illuminating.

Step by step

Making anonymous calls

Your service personnel decides whether or not your caller ID (name and phone number) is displayed on a called party's station. **Anonymous** calling is when your data is not transmitted. The settings configured can be deactivated, however, for specific calls.



- If your caller ID is transmitted: your caller ID is displayed.
- If your caller ID is suppressed: "unknown" is displayed.

Deactivating

If your service personnel permanently activated **anonymous calling** for your phone, you can deactivate this setting as follows:



Lift the handset.



Enter the code (see the table of codes → page 160) to transmit the caller information.



You hear a confirmation tone.

Activating

If your service personnel activated caller ID transmission for your phone, you can deactivate this setting as follows:



Lift the handset.



Enter the code (see the table of codes → page 160) to suppress the caller ID.



Wait until you hear the confirmation tone.

Caller ID transfer is suppressed. "Private/Anonymous" appears on the called party's display instead of the caller ID.

Step by step**Temporarily activating anonymous calling for the next call**

If your service personnel activated caller ID transmission for your phone, you can deactivate this setting for the next call as follows:



Lift the handset.



Enter the code (see the table of codes → page 160).



Wait until you hear the confirmation tone.



Dial the phone number of the party you want to contact.
Caller ID transmission is reactivated after this call.

Temporarily deactivating anonymous calling for the next call

If your service personnel suppressed caller ID transmission for your phone, you can enable this setting for the next call as follows:



Lift the handset.



Enter the code (see the table of codes → page 160).



Wait until you hear the confirmation tone.



Dial the phone number of the party you want to contact.
When you end this call, caller ID transmission is suppressed once again for the next call.

Step by step

Creating a list for selective calls

For call acceptance

You can create a list of the phone numbers from which you are willing to accept calls (also known as a selection list). Your service personnel know how long this list may be in the OpenScape Voice used on site in your facility.

A connection is set up if a caller's phone number matches a number in the selection list. If there is a match:

- the caller receives a message that the party refuses to accept any calls with this number,
- or** • the call is forwarded to an external phone number.

Contact your service personnel for information on how your OpenScape Voice is configured on site.



Lift the handset.



Enter the code (see the table of codes → page 160).

Various announcements deliver the following information:

- the name of the feature (selective call acceptance)
- the current status (active or inactive)
- the current scope of the selection list.

These announcements are followed by verbal user prompts that let you:

- add entries to the selection list
- delete entries in the selection list
- check the selection list
- activate or deactivate the function.

Step by step**For call rejection**

As for selective call acceptance, you can create a selection list with the phone numbers of parties from whom you are not willing to accept calls. Your service personnel know how long this list may be in the OpenScape Voice used on site in your facility.

A call is not connected if the caller's phone number matches a number in the selection list; the caller is notified that the called party rejects calls from this number. If the caller's number is not in the selection list, the call is to you as usual.



Lift the handset.



Enter the code (see the table of codes → page 160).

Various announcements deliver the following information:

- the name of the feature (selective call rejection)
- the current status (active or inactive)
- the current scope of the selection list.

These announcements are followed by verbal user prompts that let you:

- add entries to the selection list
- delete entries in the selection list
- check the selection list
- activate or deactivate the function.

Step by step

Anonymous calls

Rejecting

You can reject all calls from parties that activated a data protection feature (for example, caller ID suppression) to prevent their phone number from being transmitted. In this case, you are not informed that a call was rejected.



Lift the handset.



Enter the code (see the table of codes → page 160).

Accepting

You can also accept calls from parties that activated a data protection feature (for example, caller ID suppression) to prevent their phone number from being transmitted.



Lift the handset.



Enter the code (see the table of codes → page 160).

Step by step

Using abbreviated dialing

Abbreviated dialing gives you access to a central list of frequently dialed phone numbers.

You can dial a specific phone number by simply entering a digit string. As these are three-digit numbers, you can store up to 1000 phone numbers. This list is stored centrally and managed by your service personnel.



Lift the handset.



Enter the code (see the table of codes → page 160) followed by a number between 0 and 999 for the phone number you want to dial.

The number is automatically dialed.

Call tracing

You can request automatic tracing of the last received internal call. This is particularly suitable for identifying malicious, irritating or troublesome calls.



Lift the handset.



Enter the code (see the table of codes → page 160). The phone number is determined. Ask your service personnel for the result.

Step by step

Hunt group functions

To ensure optimum handling of specific calls, your telephone can be assigned to a pickup group → page 48 and/or a hunt group.

Your service personnel can incorporate multiple telephones in a hunt group. If your telephone is assigned to a hunt group, OpenScape Voice forwards calls for the members of your group in accordance with specific rules defined by your service personnel. Hunt groups are a simple solution for distributing calls to a group of telephones.

If you want another member of the group to pick up an incoming call, you can set your telephone to signal the busy status for your line to the other members of the hunt group. Hunt group calls will then no longer be forwarded to your telephone.

This feature can also be configured using the programmable feature toggle key → page 145.

Making a line busy

This prevents this line being used for calls in a hunt group.

Activating



Lift the handset.



Enter the code (see the table of codes → page 160).



Wait until you hear the confirmation tone.

Deactivating

Make the line free once more for the hunt group.



Lift the handset.



Enter the code (see the table of codes → page 160).



Wait until you hear the confirmation tone.

Step by step**Marking the last line in the hunt group chain**

Sets the "stop hunt" line in the hunt group chain. The system will stop looking for a free line in the hunt group chain after it reaches this line.

Activating

Lift the handset.



Enter the code (see the table of codes → page 160).



Wait until you hear the confirmation tone.

Deactivating

Unmark the line as the end of the hunt group chain.



Lift the handset.



Enter the code (see the table of codes → page 160).



Wait until you hear the confirmation tone.

Step by step

Reachability

You can make either serial calls or simultaneous calls on several sites. The features for this are

- Serial call
- Parallel call

Prerequisite: The service personnel has configured the respective feature for your main number in OpenScape Voice.

Serial call

Managing number lists/activating serial call

Before the serial call number can be activated, a serial call list must be created. This can be prepared either by service personnel or you can create it yourself later. Up to six numbers can be entered in the list for sites on which incoming calls including your main number should be signaled sequentially. Each number can consist of up to 30 digits.



Lift the handset.

Enter the code for the edit mode (see code table → page 160).

The edit mode opens and you hear an announcement with the following information:

- Feature name
- Current status (active/inactive)
- Number of numbers currently on the serial call list

You are prompted to do one of the following:

- Activate/deactivate the feature (only if numbers are already entered in the list)
- Call up the numbers currently entered in the list.
- Add or delete numbers
- Repeat the options in edit mode

If the serial call list is still empty, you are prompted to enter numbers in the list. As soon as you have entered a valid number, the serial call can be activated.

If the serial call is activated, incoming calls are first routed to your phone. If you do not answer within the time-frame defined by the service personnel, the next destination phone rings for the configured period of time.

Step by step

The caller is informed that the call is being routed to another station. The connection is established with the first phone that accepts the call.

If the call is not answered by any phone, it is forwarded to the configured forwarding destination (on no reply) or to a "rejection announcement".

Parallel call

Managing number lists/activating parallel call

Before the parallel call feature can be activated, a parallel call list must be created. This can be prepared either by service personnel or you can create it yourself later. Up to six numbers can be entered in the list for sites on which incoming calls including your main number should be signaled sequentially. Each number can consist of up to 30 digits.



Lift the handset.



Enter the code for the edit mode (see code table → page 160).

The edit mode opens and you hear an announcement with the following information:

- Feature name
- Current status (active/inactive)
- Number of numbers currently on the parallel call list

You are prompted to do one of the following:

- Activate/deactivate the feature (only if numbers are already entered in the list)
- Call up the numbers currently entered in the list.
- Add or delete numbers
- Repeat the options in edit mode

If the parallel call list is still empty, you are prompted to enter numbers in the list. As soon as you have entered a valid number, the parallel call can be activated.

If the parallel call is activated, incoming calls are routed to your phone and all other destination phones in the parallel call list. The connection is established with the first phone that accepts the call.

If the call is not answered by any phone, it is forwarded to the configured forwarding destination (on no reply) or to a "rejection announcement".

Step by step

Activating/deactivating parallel call via code

You can activate/deactivate the parallel call without having to change to edit mode.

Prerequisite: You have already entered numbers in the parallel call list.



Lift the handset.



Enter the code to activate or deactivate the parallel call (see code table → page 160).

Step by step

Parking a call

If you have answered a call for a colleague and cannot forward it to him, you can park the call.

Call park



You are conducting the call. Let the other party know, e.g. that you are trying to connect him.



Enter the code for parking followed by a line number (see code table → page 160).

You receive a confirmation tone. The caller hears a waiting melody.



Replace the handset

Tell your colleague that a call for him is parked and give him the line number.

Unparking

To unpark the call, your colleague must proceed as follows:



Lift the handset.



Enter the unparking code (see code table → page 160). He is prompted to enter a line number.



Enter the specified line number.



Your colleague is now connected with the waiting caller.

Silent Monitoring

If this function has been configured by service personnel and enabled for the destination phone, you can join an active call of an internal station and listen in unnoticed (muted) or with the knowledge of the target station (active).

Active silent monitoring

Station A and B are on a call. You want to listen to the call but so that Station B does not notice but so that you can still talk to Station A.

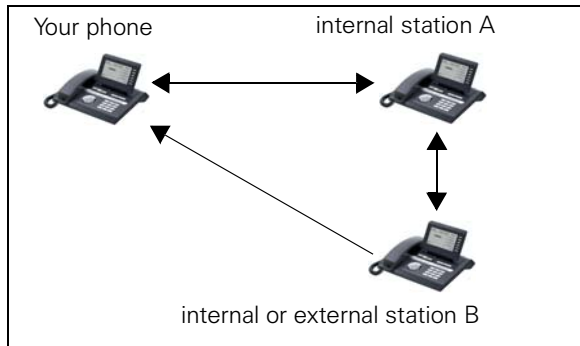

- You can hear and talk to station A.
- You can hear station B but cannot talk to him because he cannot hear you.
- Station A and B can hear and speak to each other.



Lift the handset.



Enter the code for active silent monitoring and the destination number (see code table → page 160). You are connected to the call and can listen. If necessary notify station A.



End the silent monitoring unnoticed by replacing the handset.

Step by step

Muted silent monitoring

Station A and B are on a call. You want to monitor a call but so that neither station notices.

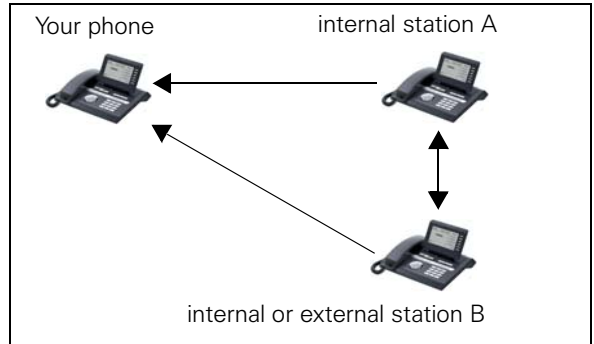

- You can hear station A but cannot talk to him because he cannot hear you
- You can hear station B but cannot talk to him because he cannot hear you.
- Station A and B can hear and speak to each other



Lift the handset.



Enter the code for active silent monitoring and the destination number (see code table → page 160). You are connected to the call and can listen.



End the silent monitoring unnoticed by replacing the handset.

Step by step

Code table for OpenScope Voice functions

Ask your service personnel to enter the latest codes in the following table. Print this page as an overview.

Function	Code	Description
Making anonymous calls off		→ page 146
Making anonymous calls on		→ page 146
Making anonymous calls temporarily on		→ page 147
Making anonymous calls temporarily off		→ page 147
List for selective call acceptance		→ page 148
List for selective call rejection		→ page 149
Rejecting anonymous calls		→ page 150
Accepting anonymous calls		→ page 150
Using abbreviated dialing		→ page 151
Call tracing		→ page 151
Making a line busy on		→ page 152
Making a line busy off		→ page 152
End of hunt group chain on		→ page 153
End of hunt group chain off		→ page 153
Edit mode for serial call		→ page 154
Edit mode for parallel call		→ page 155
Activating a parallel call		→ page 156
Deactivating a parallel call		→ page 156
Parking a call		→ page 157
Unparking a call		→ page 157
Active silent monitoring		→ page 158
Muted silent monitoring		→ page 159

Step by step

Individual phone configuration

Display

Adjusting the display to a comfortable reading angle

You can swivel the display unit. Adjust the display unit so that you can clearly read the screen.

Setting contrast

The display has six contrast levels that you can set according to your light conditions.

You can also configure this setting via the Web interface → page 195.



Settings

Press the key shown.
Select and confirm the option shown.

User

Select and confirm the option shown.

if nec.

Enter and confirm the User password.

Phone

Select and confirm the option shown.

Display

Select and confirm the option shown.

Contrast

Select and confirm the option shown.



Set and confirm the contrast.

Save & Exit

Confirm.

Step by step

Adjusting the brightness

The display has seven brightness levels that you can set according to your light conditions.



You can also configure this setting via the Web interface → page 195.



Press the key shown.

Settings

Select and confirm the option shown.

User

Select and confirm the option shown.

if nec. A small icon of a keypad, showing a grid of squares.

Enter and confirm the User password.

Phone

Select and confirm the option shown.

Display

Select and confirm the option shown.

Brightness

Select and confirm the option shown.



Set and confirm the brightness.

Save & Exit

Confirm the option shown.

Step by step

Background lighting

You can have the background lighting switch off automatically after a time defined by you.



You can also configure this setting via the Web interface → page 195.



Press the key shown.

Settings

Select and confirm the option shown.

User

Select and confirm the option shown.

if nec. (?)

Enter and confirm the User password.

Phone

Select and confirm the option shown.

Energy saving mode

Select and confirm the option shown.

Time for background lighting

Select and confirm the option shown.

The following time options are available to you:

- Background lighting: 1 minute
- Background lighting: 5 minutes
- Background lighting: 30 minutes
- Background lighting: 60 minutes
- Background lighting: 2 hours
- Background lighting: 4 hours
- Background lighting: 8 hours

The default setting is 1 minute.



Select and confirm the time.

Save & Exit

Confirm the option shown.

Step by step

Contrast for the OpenStage Key Module

If an OpenStage Key Module is connected to your OpenStage 40, you can set contrast for it.



Settings

Press the key shown.

Select and confirm the option shown.

User

Select and confirm the option shown.

if nec. 

Enter and confirm the User password.

Phone

Select and confirm the option shown.

Display

Select and confirm the option shown.

Key mod. contrast

Select and confirm the option shown.



Set and confirm the contrast.

Save & Exit

Confirm.

Step by step

Date and time

You can set the date and time display here if necessary.

You can also configure these settings via the Web interface → page 195.

Setting the time

Press the key shown.

Select and confirm the option shown.

Select and confirm the option shown.

Enter and confirm the User password.

Select and confirm the option shown.

Select and confirm the option shown.

Enter and confirm the time.

Confirm.

Setting the date

Press the key shown.

Select and confirm the option shown.

Select and confirm the option shown.

Enter and confirm the User password.

Select and confirm the option shown.

Select and confirm the option shown.

Enter and confirm the date.

Confirm.



Settings

User

if nec.



Date and time

Time



Save & Exit



Settings

User

if nec.



Date and time

Date



Save & Exit

Step by step

Setting daylight saving time

Prerequisite: **Auto DST** is deactivated → page 167.



You can also configure this setting via the Web interface → page 195.



Press the key shown.

Settings

Select and confirm the option shown.

User

Select and confirm the option shown.

if nec.

Enter and confirm the User password.

Date and time

Select and confirm the option shown.

Daylight saving

Select and confirm the option shown.

Yes

Select and confirm the option shown in the context menu.

Save & Exit

Confirm.

Setting the difference between daylight saving and standard time

Prerequisite: **Auto DST** is deactivated → page 167.

Enter the difference to be used for daylight saving time.



You can also configure this setting via the Web interface → page 195.



Press the key shown.

Settings

Select and confirm the option shown.

User

Select and confirm the option shown.

if nec.

Enter and confirm the User password.

Date and time

Select and confirm the option shown.

Step by step

Difference (mins)

Select and confirm the option shown.



Enter and confirm the difference between daylight and standard time in minutes.

Save & Exit

Confirm.

Automatic daylight saving time

The **Auto DST** setting (automatic time-update) is provided for information purposes and can only be changed by your service personnel.



You can also access this information via the Web interface → page 195.



Press the key shown.

Settings

Select and confirm the option shown.

User

Select and confirm the option shown.

if nec.



Enter and confirm the user password.

Date and time?

Select and confirm the option shown.

Daylight saving time must be manually set if a **No** is entered for **Auto DST** → page 166.

Step by step



You can also configure this setting via the Web interface → page 195.



Press the key shown.

Settings

Select and confirm the option shown.

User

Select and confirm the option shown.

if nec.

Enter and confirm the User password.

Locality

Select and confirm the option shown.

Time format

Select and confirm the option shown.

24 hour

Select and confirm the time format (12- or 24-hour display) in the context menu.

Save & Exit

Confirm.

Date display format



You can also configure this setting via the Web interface → page 195.



Press the key shown.

Settings

Select and confirm the option shown.

User

Select and confirm the option shown.

if nec.

Enter and confirm the User password.

Locality

Select and confirm the option shown.

Date format

Select and confirm the option shown.

dd/mm/yyyy

Select and confirm the format you want.

Save & Exit

Confirm.

Step by step

Audio

Volumes

Use this selection to set the following volumes:

- Loudspeaker
- Ringer
- Handset
- Headset
- Handsfree
- Rollover

Example: **Handset**



Settings

Press the key shown.

Select and confirm the option shown.

User

Select and confirm the option shown.

if nec. 

Enter and confirm the User password.

Audio

Select and confirm the option shown.

Volumes

Select and confirm the option shown.

Handset

Select and confirm the volume you want to adjust (for example, "Handset").



Set and confirm the volume.

An acoustic sample of the current volume is output via audio feedback when you adjust the volume.

Save & Exit

Confirm.

Step by step

Settings

Room character

To ensure that the other party can hear you properly in speakerphone mode, you can adjust the phone to the room acoustics by choosing one of the following room character conditions: "Normal", "Echoing", "Muffled" .



You can also configure this setting via the Web interface → page 195.



Press the key shown.

Settings

Select and confirm the option shown.

User

Select and confirm the option shown.

if nec.

Enter and confirm the User password.

Audio

Select and confirm the option shown.

Settings

Select and confirm the option shown.

Room character

Select and confirm the option shown.

Normal

Select and confirm the room character in the context menu (for example, "Normal") (→ page 197).

Save & Exit

Confirm.

Ringtone

If your service personnel has loaded suitable files to the phone, you can select a realtone file in *.mp3 or *.wav format for the ringer tone. If no individual audio files are available the "pattern" ringtone is preset.



You can also configure this setting via the Web interface → page 195.



Press the key shown.

Settings

Select and confirm the option shown.

User

Select and confirm the option shown.

Step by step

if nec.



Enter and confirm the user password.

Audio

Select and confirm the option shown.

Settings?

Select and confirm the option shown.

Ringer file

Select and confirm the option shown.

ABC.wav

Select and confirm the required ringer file¹ or "pattern."
You will immediately hear the associated ringer melody.
Confirm current ringtone file.

Save & Exit

Confirm the selected ringtone to use it or try a different ringtone.

Pattern melody

You can also configure this setting via the Web interface
→ page 195.

Prerequisite: You have chosen the "pattern" ringtone,
see → page 170.



Press the key shown.

Settings

Select and confirm the option shown.

User

Select and confirm the option shown.

if nec.



Enter and confirm the User password.

Audio

Select and confirm the option shown.

Settings

Select and confirm the option shown.

Ringer melody

Select and confirm the option shown.

4

Select the required pattern melody^[1] between 1 and 8
(e. g. **4**). You will immediately hear the corresponding
Ringer melody. Confirm the selected Ringer melody.

Save & Exit

Select and confirm the option shown.

1. The phone displays the current setting.

Step by step



Pattern sequence

You can also configure this setting via the Web interface → page 195.

Prerequisite: You have chosen the "pattern" ringtone, see → page 170.



Press the key shown.

Settings

Select and confirm the option shown.

User

Select and confirm the option shown.

Audio

Select and confirm the option shown.

Settings

Select and confirm the option shown.

Ringer tone sequence

Select and confirm the option shown.

2

Select your desired Ringer tone sequence between 1 and 3 (e. g. **2**) You immediately hear the set Ringer melody with the chosen Ringer tone sequence. Confirm the selected setting.

Save & Exit

Select and confirm the option shown.

Step by step

Opening listening mode

Select the mode here that you prefer for open listening (see → page 45).



You can also configure this setting via the Web interface → page 195.



Press the key shown.

Settings

Select and confirm the option shown.

User

Select and confirm the option shown.

if nec.

Enter and confirm the User password.

Audio

Select and confirm the option shown.

Settings

Select and confirm the option shown.

Open listening

Select and confirm the option shown.

Standard mode

Select and confirm the setting you want in the context menu ("Standard mode" or "US mode).

Save & Exit

Confirm.

Step by step

Setting headset port use

Here you set whether you are using a wired or cordless DECT headset.



You can also configure this setting via the Web interface → page 195.



Press the key shown.

Settings

Select and confirm the option shown.

User

Confirm.

if nec.

Enter and confirm the user password.

Audio

Select and confirm the option shown.

Settings

Select and confirm the option shown.

Headset socket

Select the option shown.

Wired headset?

From the following setting^[1] select and confirm the option shown in the context menu.

- Wired headset
- Cordless headset
- Conference unit

Save & Exit

Select and confirm the option shown.

1. The phone displays the current setting.

Step by step

Tone and indication with an unsecured voice connection

Use this option to activate an alerting tone that you hear when a secure voice connection with the party you are currently talking to ceases to be secure. The message "Nonsecure connection" also appears.

Prerequisite: Secure connection setup is the preference set by your service personnel.



You can also configure this setting via the Web interface → page 195.



Press the key shown.

Settings

Select and confirm the option shown.

User

Select and confirm the option shown.

if nec.

Enter and confirm the User password.

Configuration

Select and confirm the option shown.

Connected calls

Select and confirm the option shown.

Secure call alert

Select and confirm the option shown.

Yes

Select and confirm the option shown in the context menu.

Save & Exit

Select and confirm the option shown.

Step by step

Key click

You can select here whether a tone should be heard when a key is pressed. You can also decide whether this should apply for all keys or only those on the keypad. In addition, you can adjust the tone volume or disable the tone.



You can also configure this setting via the Web interface → page 195.



Press the key shown.

Settings

Select and confirm the option shown.

User

Select and confirm the option shown.

if nec.

Enter and confirm the User password.

Phone

Select and confirm the option shown.

Key click

Select and confirm the option shown.

Adjusting the volume for the Key click

Volume

Select and confirm the option shown.

Medium

For instance, select and confirm a medium volume level. You can also select one of the following three options:

- Low
- High
- Off (for no click)

Key selection

Keys

Select and confirm the option shown.

Keypad only

Select and confirm if the setting is only to apply for the character input keys.

or

All keys

Select and confirm the option shown.

Save & Exit

Confirm the option shown.

Step by step

Setting the language and country

Selecting a language



You can also configure this setting via the Web interface
→ page 195.



Press the key shown.

Settings

Select and confirm the option shown.

User

Select and confirm the option shown.

if nec. 

Enter and confirm the User password.

Locality?

Select and confirm the option shown.

Speech?

Select and confirm the option shown.

Deutsch

Select and confirm the language^[1] in the context menu.

Save & Exit

Confirm.

1. The phone displays the current setting.

Step by step

You may choose from the following languages:

1. Bahasa Indonesia
2. Bahasa Malaysia
3. Brasileiro
4. Català
5. Čeština
6. Dansk
7. Deutsch
8. Eesti keel
9. English
10. English(US)
11. Español
12. Français
13. Hrvatski
14. Italiano
15. Latviešu Valoda
16. **Lietuvių Kalba**
17. Magyar
18. Nederlands
19. Norsk
20. Polski
21. Português
22. Română
23. Slovenčina
24. Slovenski Jezik
25. Srpski Jezik
26. Suomi
27. Svenska
28. Türkçe
29. Ελληνικά
30. Български
31. Македонски Јазик
32. Русский
33. Српски Језик
34. 中文
35. 日本語

Step by step

Country-specific setting

Adapt your phone settings to suit the country-specific conditions (for example, transmission parameters).



You can also configure this setting via the Web interface → page 195.



Press the key shown.

Settings

Select and confirm the option shown.

User

Select and confirm the option shown.

if nec.

Enter and confirm the User password.

Locality

Select and confirm the option shown.

Country

Select and confirm the option shown.

Germany

Select and confirm the country ^[1] in the context menu.

Save & Exit

Confirm.

You may choose from the following countries:

- | | | | |
|--------------------|----|------------------------|----|
| 1. Argentina | AR | 20. Luxembourg | LU |
| 2. Australia | AT | 21. Mexico | MX |
| 3. Austria | AU | 22. Netherlands | NL |
| 4. Belgium | BE | 23. New Zealand | NZ |
| 5. Brazil | BR | 24. Norway | NO |
| 6. Canada | CA | 25. Poland | PL |
| 7. China | CN | 26. Portugal | PT |
| 8. Chile | CL | 27. Russian Federation | RU |
| 9. Croatia | HR | 28. Singapore | SG |
| 10. Czech Republic | CZ | 29. Slovakia | SK |
| 11. Denmark | DK | 30. South Africa | ZA |
| 12. Finland | FI | 31. Spain | ES |
| 13. France | FR | 32. Sweden | SE |
| 14. Germany | DE | 33. Switzerland | CH |
| 15. Hungary | HU | 34. Thailand | TH |
| 16. India | IN | 35. Turkey | TR |
| 17. Ireland | IE | 36. United Kingdom | GB |
| 18. Italy | IT | 37. United States | US |
| 19. Japan | JP | 38. Vietnam | VN |

1. The phone displays the current setting.

Step by step

Context menu

After a connection is set up, a context menu appears with dependent functions. You can activate/deactivate the automatic display and can also set how long the context menu should be displayed.

You can also configure this setting via the Web interface → page 195.



Settings

Select and confirm the option shown.

User

Select and confirm the option shown.

if nec.

Enter and confirm the User password.

Configuration

Select and confirm the option shown.

Context menu

Select and confirm the option shown.

Activating/deactivating automatic menu display

Automatic menu...

Select and confirm the option shown.

Yes

In the context menu select and confirm to activate automatic menu display.

Save & Exit

Select and confirm the option shown.

Setting the display time

Display time

Select and confirm the option shown.

20

In the context menu select and confirm a value from the following options:

- 5
- 10
- 20
- 30
- 60
- 120
- Unlimited display

Save & Exit

Select and confirm the option shown.

Step by step

Network information

This information overview in the user area of the service menu provides you with information about the IP address or name of the phone and the HTML address of the web-interface. It also provides real-time data about the network activity of the phone.



Settings

User

if nec. 

Network information



Press the key shown.

Select and confirm the option shown.

Select and confirm the option shown.

Enter and confirm the user password.

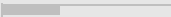
Select and confirm for the following overview:

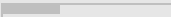
Network information
Options: Exit→
IP address: 192.168.1.9
[WBM URL http://192.168.1.
DNS domain: opera.local
LAN RX: 
LAN TX: 
PC RX: 
PC TX: 
LAN autonegotiated: Yes
LAN information: 100 Mbps full
PC autonegotiated: Yes
PC information: Link down

IP Address: Displays the IP address or name which was assigned to the phone.

WBM URL: HTTP address of the Web interface. This address is specified in the Internet browser and is used to call the Web interface of the phone in the browser.

DNS domain: The administrator can also assign the phone to the IP address of a DNS domain (for example, http://my-openStage.phone/).

Step by step

Resetting user data

The following user-specific settings changed via the phone menu or the Web interface can be reset to factory settings.

- Display contrast
- Language setting
- Audio settings
 - Volumes
 - Settings
- Call lists
 - All entries are deleted
- Programmable keys
 - All personalized programming is deleted (see also → page 77).

Attention: All data is reset **without** a warning tone.

Initiating the reset



Press the key shown.

Settings

Select and confirm the option shown.

User

Confirm.

if nec. 

Enter and confirm the user password.

Reset

Select and confirm the option shown.

Reset all user data

Select and confirm "Reset all user data." The user data is reset to factory settings.

Step by step

Call recording

A central voice recorder is installed in the network for recording calls to which your telephone connects in order to record the current voice traffic. The recorder records the entire voice flow of two or more participants.

You should configure a recording button in order to simplify handling of manual call recording → page 70. It is assumed in the description below that a corresponding key has been configured.

Call recording modes

The service personnel can configure the following operating modes for call recording:

- Manual
- AutoStart
- All Calls
- Disabled

The following settings are possible to audibly signal the recording:

- Repeated
- Single Shot
- Off

Check with your service personnel as to which settings were made for your phone.

Mode: ALL CALLS:

The telephone starts and stops the recorder automatically in order to ensure that all calls are being recorded.

Mode: MANUAL

You decide when the recorder is started and stopped or paused. If the recorder is switched on, all further calls will be recorded. If you pause the recorder then nothing will be recorded. If there are no calls, then the recorder likewise pauses.

Mode: AUTOSTART

The telephone starts the recorder automatically. You can stop or pause the recorder yourself however and restart it. If a call has already been recorded, new

Step by step

incoming and outgoing calls will also be recorded. If you pause the recorder during a call, special calls such as consultation calls, call pickups and second calls will not be recorded as long as the recorder is paused. If the telephone reverts to idle status, the AutoStart process is set up again for the next call.

Explanations of recording

Recordable calls

A recordable call is any call that has a call connection status on the telephone. This can be any incoming or outgoing call. It is immaterial here whether a call is set up directly via the telephone or via an application.

- Outgoing
- Incoming
- Consultation
- Pickup
- Reconnect
- Second call
- Connected call
- Conference¹
- Automatic call acceptance
- Secured or unsecured line

Non-recordable calls

- Outgoing calls that have not yet reached full connection status, such as a ringing call.
- Calls on hold

1. Server-based conference only

Step by step

Enhanced functions:

1. A conference¹ can be set up or cleared down during recording.
2. A consultation can be performed during recording.
3. Call transfer is also available during recording.
4. A second call can be accepted during recording.

The following features are not supported:

1. Playing back recordings over the telephone.
2. Deleting recordings over the telephone.
3. Functions for editing recordings over the telephone.

Recording tips

You will receive the following advisories while a call is being recorded:

- The recording symbol  on the display (permanent)
- Beep (repeated at intervals for you and your call partner)
- Beep (single at the start of recording for you and your call partner)

The audible advisory can also be switched off. Please check with the relevant service personnel.

Multiline

In terms of call recording, no distinction is made between multiline and singleline. If recording has started, recording is performed, otherwise not. The recording status of a line persists as long as calls are connected to this line.

For example, if line A is being recorded (initiated manually) and you switch to line B or line A is placed on manual hold and you switch to line B, the recording is ended and a partial recording saved.

If you disable recording for the call on line B (mode = manual or auto start) and switch back to line A, the recording for line A is not started again.

The modes mentioned (All Calls, AutoStart or Manual) refer to the telephone and are therefore the same for all lines.





1. Server-based conference only

Step by step

Recording calls

Using the call recording feature

The recording function can be used in a similar way to a recorder, for example for recording music. The recorder can be:

- switched on (standby )
- switched off or stopped ()
- started ()
- paused ()

The symbols used here by way of example can be found on practically any hardware and software recorder.

Automatic call recording

This is the simplest mode. If you have accepted a call or called a subscriber and the subscriber answers, the call is recorded automatically. Refer to → page 185 to check which calls this can be.

As soon as the recording starts, you will see the recording symbol  and hear a beep (see also → page 185).

You cannot pause the recording manually in this mode.

Step by step

Manual call recording

Activating or deactivating call recording when the telephone is in idle mode.

Prerequisite: Manual mode is selected. The recording button is configured and indicates the status.

Recording on

Recording off

or



Press the recording button to enable the option - the LED key lights up.



or press the key shown to disable the option - the LED extinguishes.

The recording button also indicates the status change if you activated or deactivated call recording via the context menu.

Call recording with AutoStart

Standby mode is activated in principle in idle mode. The recording button LED lights up. You cannot switch off the recorder. As soon as a call is set up, call recording starts automatically.



Lift the handset.

or



Press the key shown.



The station answers. You hear a beep, the recording symbol $\text{O} \text{O}$ is shown on the display and the recording button LED remains lighting. The call is now being recorded (see also → page 185)

You can pause the recording at any time and continue it again.

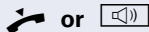

or



If you end the call, the AutoStart process is set up again for the next call.

Step by step

Controlling call recording

Starting call recording manually during a call

Prerequisite: Manual mode or AutoStart is selected. You are conducting a call. Recording has not started. The recording button LED is not lighting.



You are conducting a call (see also → page 185).



Press the recording button to start the recording - the LED key lights up.

You hear a beep and the recording symbol $\text{O} \text{O}$ is shown on the display. The call is now being recorded (see also → page 185)

Pausing call recording manually during a call

Prerequisite: Manual mode or AutoStart is selected. You are conducting a call. Recording has started. The recording button LED lights up.



You are conducting a call (see also → page 185).



Press the recording button to pause the recording - the LED extinguishes and the recording symbol $\text{O} \text{O}$ on the display disappears.

You can start the recording again at any time, for example to continue recording the current call.

Ending call recording automatically

Prerequisite: You are conducting a call. Recording has started. The recording button LED lights up.

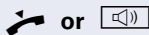

The recording is ended automatically as soon as the call is terminated or if the call status changes so that the call is no longer being recorded - for example if a line is placed on manual hold and another line is seized (Multiline).

The LED extinguishes and the recording symbol $\text{O} \text{O}$ on the display disappears.

Consultation during call recording

Prerequisite: You are conducting a call. Recording has started. The recording button LED is lighting.

Step by step

You initiate a consultation – your main call is placed on hold as a result while the consultation is being performed.



The recording is paused while you initiate the consultation. The recording symbol QD on the display disappears.



If the consultation partner answers, the consultation call is recorded. You hear a beep and the recording symbol QD is shown on the display again.

You can now terminate the consultation call or for example switch back to the first call party (alternate) while the consultation call is placed on hold.

Second call during call recording

Prerequisite: You are conducting a call. Recording has started. The recording button LED is lighting.



You are conducting a call. You hear a beep and the recording symbol QD is shown on the display. The call is now being recorded.

A second call party camps on → page 86.

In the pop-up menu:

Accept

Select and confirm the option shown.

You are connected with the second party. You hear a beep and the recording symbol QD is shown in the line for the second call – this call is now being recorded. The first party is placed on hold.

Step by step

Alternate

Call recording while alternating

Prerequisite: You have an active or held consultation or second call. Recording has started. The recording button LED is lighting.



You are connected with the second party. You hear a beep and the recording symbol  is shown in the line for the second call.

Select and confirm the option shown in the context menu for this connection.



You are switched to the main call. You hear a beep and the recording symbol  is shown in the line for the main call – this call is now being recorded.

You can pause and restart the recording at any time in manual and auto start modes.

Your call is paused and reconnected during the recording.

Prerequisite: You are conducting a call that is being recorded.



Your call partner has placed the call on hold. You hear the music on hold. The recording is paused and the recording symbol  has disappeared from the display.



Your call partner resumes the call. You hear a beep and the recording symbol  is shown on the display.

Step by step

Setting up a conference during recording

Prerequisite: You are conducting a consultation call → page 56 or you have accepted a second call → page 86 and the "System conference" feature was configured by the service personnel. Recording has started. The main call is placed on hold. The recording button LED is lighting.

Conference

Select and confirm the option shown in the connection's context menu. You are connected to both parties at once. The conference is displayed with the current participants.

You hear a beep and the recording symbol  is shown in the line for the conference call.

Adding conference participants during the recording

Prerequisite: You have set up a conference. The "System conference" feature was configured by the service personnel. The conference call is now being recorded.



You have performed a consultation or accepted a second call (→ page 56 or → page 86). The conference call is placed on hold.

You hear a beep and the recording symbol  is shown in the line for the consultation or second call. The call is now being recorded.

Conference

Select the option shown in the context menu for the consultation or second call in order to include the new participant in the conference. The conference is displayed with all current participants.

You hear a beep and the recording symbol  is shown again in the line for the conference call.

Step by step

Your call is included in a conference during the recording.

Prerequisite: You are conducting a call that is being recorded. You are to be included in a conference by your call partner. You are placed on hold while the conference is being set up.



You hear the music on hold while your call partner is setting up the conference. The recording is paused and the recording symbol QO has disappeared from the display.



Your call partner answers again and you are connected to the conference. You hear a beep and the recording symbol QO is shown in the "Conference" line. The conference call is now being recorded.

Putting a line on hold manually during the recording

There are two options for placing a line manually on hold:

- You place the active line on hold during the call recording and then resume the call on this line.
- You seize a different line during call recording. The first line is placed on manual hold.

Prerequisite: The telephone has more than one line configured. The active line is being recorded. The recording button LED is lighting.

Holding and retrieving the call on the line



You are conducting a call, for example on line A. You hear a beep and the recording symbol QO is shown on the display. The call is now being recorded.



Press line key A. The line key LED starts flickering. The call is placed on hold. The recording is paused while the call is on hold. The recording symbol QO on the display disappears.

Step by step**Retrieving a held call:**

Press line key A. The line key LED lights up. The call is retrieved. You hear a beep and the recording symbol $\underline{Q}\underline{O}$ is shown on the display again. Call recording is continued.

Holding a call on the line and conducting a call on a different line

Press line key B – the LED lights up. You hear a beep and the recording symbol $\underline{Q}\underline{O}$ is shown on the display for line B – this call on line B is being recorded. Line A is placed on hold, call recording of line A has been terminated.



Press line key A to resume the call. You hear a beep and the recording symbol $\underline{Q}\underline{O}$ is shown on the display for line A – a new recording of line A commences.

Step by step

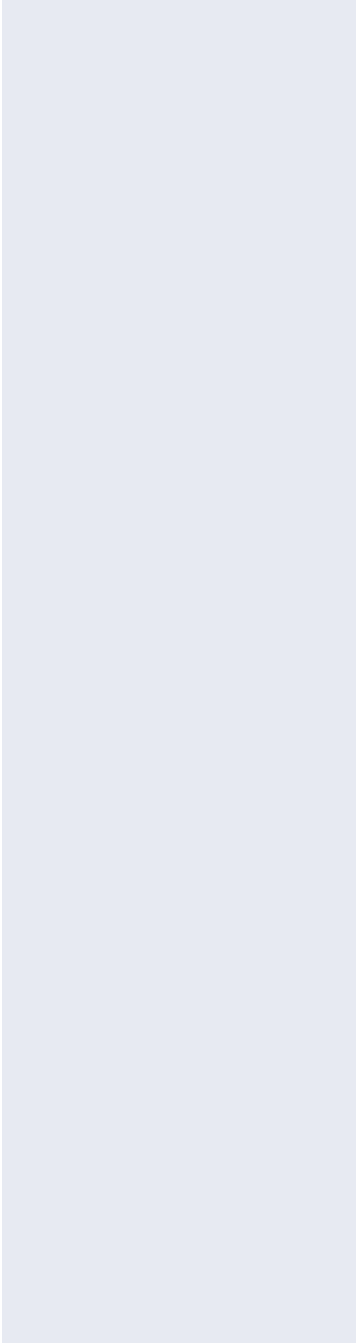

Web interface (WBM)

General

You can configure a number of settings for your phone via the Web interface. Communication is via a secure HTTPS connection.

Calling up the Web interface

 For more information on the IP address, the Web interface address, and how to connect the telephone to the network, refer to the section entitled "Network information" → page 182.

To call up the interface, open a Web browser and enter the following:

http://[IP address of the phone]:[port] or

https://[IP address of the phone]

[IP address of the phone] is the IP address of your phone.

https://[Name of the phone]

[Name of the phone] which was assigned by service personnel.

[Port] is the port address of the phone's HTTP server and must be 8085.

 You might receive a certificate notification from the browser. Follow the instructions to download the certificate.

You will be prompted to configure a user password the first time you call up the Web interface → page 136. You must log on with this password in future every time you want to open the User Pages.

Administrator Pages

This area lets you configure settings for administering your phone and the network environment. Access to the Administrator Pages is protected by the admin password. For more information, contact your service personnel or refer to the administration manual.

User pages

The Web interface homepage opens once you have entered and confirmed the phone's IP address:

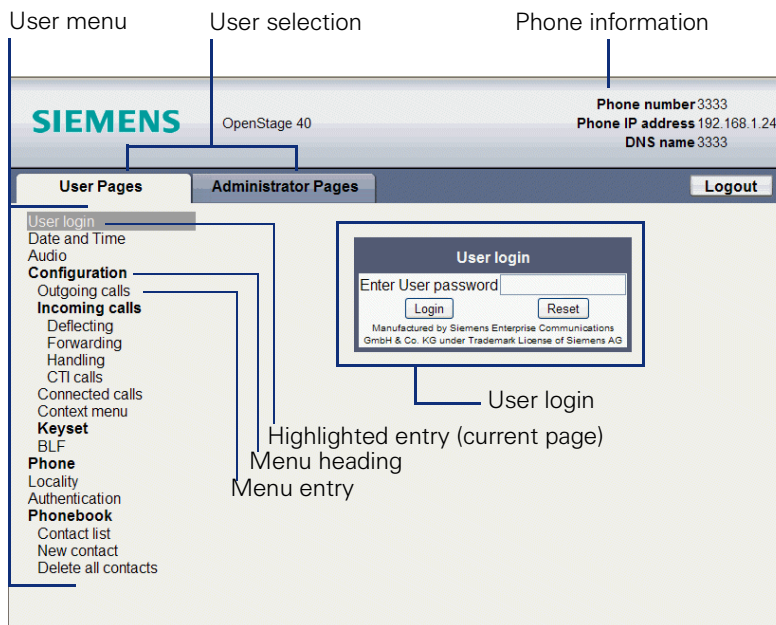

1. Click a menu heading to display the individual menu entries. Click the menu heading again to close the menu.
2. Click a menu entry to open the corresponding form.
3. Make the desired changes.
4. Click the corresponding button to save or discard your changes.

Button functions

- "Login": Log on to the phone after you have entered the user password
- "Submit": Apply changes
- "Reset": Reset original values
- "Refresh": Update the values.
- "Logout": Log off the phone





User menu

All settings that you can make via the Web interface's user menu can also be made via the phone's user menu





User Pages

User login  → page 136

















Date and Time

- Local time  → page 165
- Local date (day, month, year)  → page 165
- Allow daylight saving  → page 166
- Difference (minutes)  → page 166
- Auto time change  → page 167



























Audio

- Ringer melody ( → page 171)
- Ringer tone sequence ( → page 172)
- Ring file ( → page 170)
- Room Character ( → page 170)
- Open listening ( → page 173)

Configuration





- Outgoing calls
 - Autodial delay (seconds)  → page 98
 - Allow callback: busy  → page 68
 - Allow callback: no reply  → page 68
 - Allow busy when dialing  → page 99
 - Allow transfer on ring  → page 92
 - Allow immediate dialing  → page 53
- **Incoming calls**
 - Deflecting
 - Allow deflection ( → page 79)
 - Default deflect destination  → page 79
 - Deflect to DSS  → page 79
 - Forwarding
 - Settings
 - Forwarding Favorites Destination 1 to Destination 5  → page 79
 - Forward all calls allowed  → page 63
 - to  → page 62
 - Forward on busy allowed  → page 63
 - to  → page 62
 - Forward on no reply allowed  → page 63
 - to  → page 62
 - No reply delay (seconds)^[1]  → page 62

[1]. Only if "Server features" was deactivated by your service personnel





- Alerts
 - Visual alerts  → page 81
 - Audible alerts  → page 81
 - Forwarding party  → page 65
- Handling
 - Allow call waiting  → page 88
 - Allow DND  → page 135
 - Allow busy when dialing  → page 99
- CTI calls
 - Allow auto-answer  → page 93
 - Allow beep on auto-answer  → page 93
 - Allow beep on auto-reconnect  → page 94
- Connected calls
 - Allow call transfer  → page 91
 - Allow call joining  → page 59
 - Allow exit conference  → page 102
 - Allow hold reminder  → page 83
 - Hold reminder delay (minutes)  → page 84
 - Allow music on hold  → page 85
 - Allow conferences  → page 101
 - Allow secure call alert  → page 175
 - Toggle associate  → page 89
- Context menu
 - Auto Show menu  → page 181
 - Auto hide time (sec.)  → page 181
- **Keypad**
 - Lines
 - Ring delay (seconds)  → page 129
 - Allow in overview  → page 128
 - Address^[1]
 - Primary line^[1]
 - Ring on/off^[1]
 - Selection order^[1]
 - Hot-/Warmline^[1]
 - Hot warm destination  → page 117
 - Overview
 - Use FPK order  → page 130
 - Add all lines  → page 130
 - Reordering directions: Move down, Move to bottom, Move to top, Move up  → page 130
- BLF
 - Busy Lamp Field: **not** for OpenScope Voice

[1]. Information - read only

Phone

- Display settings
 - Display brightness
 - -3
 - -2
 - -1
 - Default
 - +1
 - +2
 - +3
 - Contrast  → page 161
 - Key module contrast  → page 164
- Program keys
 - Normal
 - Edit  → page 71.
 - Shifted
 - Edit  → page 71.
- Key Module 1 (if available such as Program keys)
- Key Module 2 (if available such as Program keys)
- Tastenklick
 - Lautstärke
 - Off
 - Low
 - Mittel
 - High
 - Tasten
 - Nur Tastenfeld
 - Alle Tasten
- Energy saving mode
 - Time for background lighting
 - 1 minute
 - 5 minutes
 - 30 minutes
 - 60 minutes
 - 2 hours
 - 4 hours
 - 8 hours



Locality

- Country  → page 179
- Language  → page 177
- Date format  → page 168
- Time format  → page 168

Authentication

- Old password
- New password  → page 136
- Confirm password

Phone book

- Contact list  → page 105
- New contact  → page 105
- Delete all contacts  → page 106

Fixing problems

Caring for your telephone

- Never allow the telephone to come into contact with coloring, oily or aggressive agents.
- Always use a damp or antistatic cloth to clean the telephone. Never use a dry cloth.
- If the telephone is very dirty, clean it with a diluted neutral cleaner containing surfactants, such as a dish detergent. Afterwards remove all traces of the cleaner with a damp cloth (using water only).
- Never use aggressive or alcohol-based cleansers on plastic parts. The use of scouring agents is also forbidden.

Troubleshooting

Pressed key does not respond:

If the telephone is locked redial keys cannot be used. This also applies when an emergency number is saved on it.

Check whether your telephone is locked ("Phone locked. To unlock enter the PIN" appears on the screen). If the phone is locked, unlock it.

The phone does not ring on call:

Check whether the ringtone is deactivated (see icon in the status bar on the display → page 26). If it is deactivated, activate the ringtone

The displayed time is incorrect:

The time is corrected automatically over night after 24 hours at the latest.

You cannot dial a number:

Check whether your telephone is locked ("Phone locked. To unlock enter the PIN" appears on the screen.). If the phone is locked, unlock it.

To correct any other problems:

First contact the relevant service personnel. If the service personnel are unable to correct the problem, contact Customer Service.

Contact partner in the case of problems

Contact your service personnel if a fault persists for more than five minutes, for example.

Labeling keys

The following options are available for labeling keys of the OpenStage Key Module 15 (→ page 18) with the functions or numbers assigned to them:

Labeling

- By hand:
Labeling strips are supplied with your OpenStage Key Module 15. Note the function or name in the white field on the strip and insert the strip on your OpenStage Key Module 15.
- With a computer via the Internet:
You can find the "online labeling tool" together with the user interface at http://wiki.siemens-enterprise.com/index.php/Key_Labeling_Tool.
- Select the appropriate key labeling tool in your language. You can use the tool online via the browser or you can download it for local use.

Local user menu

Opening the user menu on the phone

Press the  key to open the telephone menu.

On the **Settings** menu, open the **User** menu. You are prompted to enter the User password → page 136. Confirm this with **OK**. The options of the user menu are available.

User menu display

The majority of settings that can be made via the user menu on the phone, can also be made via the web interface → page 195.







Changes are usually confirmed using the **Save & Exit** option or discarded using the **Exit (Discard Changes)** option. You can exit the current menu level using the left key of the navigator (→ page 20).

User

Date and time?

- Option: Save & Exit
 - Exit (Discard Changes) → page 165
- Time: hh:mm → page 165
- Date: DD.MM.YYYY → page 165
- Daylight saving: Yes → page 166
 - Yes
 - No
- Difference (mins): mm → page 166
- Auto DST: Yes/No → page 167

Audio?

- Volumes?
 - Option: Save & Exit
 - Exit (Discard Changes) → page 169
 - Loudspeaker:  → page 169
 - Ringer:  → page 169
 - Handset:  → page 169
 - Headset:  → page 169
 - Handsfree:  → page 169
 - Rollover:  → page 169
- Settings?
 - Option: Save & Exit
 - Exit (Discard Changes) → page 170
 - Ringtone: Ring file
 - Pattern
 - Ringer1.wav

- Ringer2.wav
- Ringer3.wav
- Ringer4.wav
- Ringer5.wav
- Ringer6.wav
- Ringer melody: 2 → page 171
 - 1
 - 2
 - 3
 - 4
 - 5
 - 6
 - 7
 - 8
- Ringer tone sequence: 1 → page 172
 - 1
 - 2
 - 3
- Room character: Normal → page 170
 - Normal
 - Echoing
 - Muffled
- Open listening: Standard mode → page 173
 - Standard mode
 - US mode
- Headset socket: Cordless headset → page 174
 - Wired headset
 - Cordless headset
 - Conference unit

⊞ User Configuration?

– Outgoing calls?

- Option: Save & Exit
- Exit (Discard Changes)
- Autodial delay: 6 → page 98
 - 1
 - 2
 - 3
 - 4
 - 5
 - 6
 - 7
 - 8
 - 9
- Callback: busy: Yes → page 68
 - Yes
 - No
- Callback: no reply: Yes → page 68

- Yes
- No
- Busy when dialling: Yes → page 99
 - Yes
 - No
- Transfer on ring: Yes → page 92
 - Yes
 - No
- Immediate dialling: Yes → page 53
 - Yes
 - No

- Incoming calls?

- Deflecting?
 - Option: Save & Exit
 - Exit (Discard Changes)
 - Allow deflection: Yes → page 79
 - Yes
 - No
 - Default destination: → page 79
 - Deflect to DSS: Yes/No^[1] → page 79
- Forwarding?
 - Settings?
 - Option: Save & Exit
 - Exit (Discard Changes)
 - All calls: Off → page 61
 - On
 - Off
 - Destination: Destination 1 to Destination 5
 - Edit favourites
 - Option: Save & Exit
 - Exit (Discard Changes)
 - Destination 1
 - Destination 2
 - Destination 3
 - Destination 4
 - Destination 5
 - Busy: Off → page 61
 - On
 - Off
 - Destination: Destination 1 to Destination 5
 - Edit favourites?
 - Option: Save & Exit
 - Exit (Discard Changes)
 - Destination 1
 - Destination 2
 - Destination 3

[1]. Information - read only

- Destination 4
 - Destination 5
- No reply: Off → page 61
 - On
 - Off
- Destination: Destination 1 to Destination 5
 - Edit favourites?
 - Option: Save & Exit
 - Exit (Discard Changes)
 - Destination 1
 - Destination 2
 - Destination 3
 - Destination 4
 - Destination 5
 - Duration: 16
- Alerts
 - Option: Save & Exit
 - Exit (Discard Changes)
 - Visual alerts: No → page 81
 - Yes
 - No
 - Audible alerts: No → page 81
 - Yes
 - No
 - Forwarding party: Display last → page 81
 - Display first
 - Display last
- Handling
 - Option: Save & Exit
 - Exit (Discard Changes)
 - Allow call waiting: Yes → page 88
 - Yes
 - No
 - Allow DND: Yes → page 135
 - Yes
 - No
 - Busy when dialling: Yes → page 99
 - Yes
 - No
- CTI calls?
 - Option: Save & Exit
 - Exit (Discard Changes)
 - Auto-answer: Yes → page 93
 - Yes
 - No
 - Beep on auto-answer: Yes → page 93
 - Yes

- No
- Beep on auto-unhold: Yes → page 94
- Yes
- No

- Connected calls?

- Option: Save & Exit
- Exit (Discard Changes)
- Allow call transfer: Yes → page 91
- No?
- Return?
- Allow call joining: Yes → page 59
- Yes
- No
- Join in conferences: Yes → page 102
- Yes
- No
- Allow hold rem.: Yes → page 83
- Yes
- No
- Hold rem. delay: 8 → page 84
- 3?
- 4?
- 5?
- 6?
- 7?
- 8?
- 9?
- 10?
- 11?
- 12?
- 13?
- 14?
- 15?
- Music on hold: Yes → page 85
- Yes
- No
- Allow conferences: Yes → page 101
- Yes
- No
- Secure call alert: Yes → page 175
- Yes
- No
- Toggle associate: Yes → page 89
- Yes
- No

- Context menu

- Automatic display menu Yes → page 181
 - Yes
 - No
- Display time 20 → page 181
 - 5
 - 10
 - 20
 - 30
 - 60
 - 120
 - Unlimited no.



- Keyset?

- Lines?
 - Line (one of **eight** possible)
 - Option: Save & Exit
 - Exit (Discard Changes)
 - Ring delay: 0 → page 129
 - Allow in overview: Yes → page 128
 - Yes
 - No
 - Hot warm action^[1]: No action
 - Hot warm dest: nnnn → page 117
 - Address^[1]: nnnn
 - Ring on/off^[1]: On
 - Selection order^[1]: 1
- Overview? → page 130
 - Line (up to **eight** lines)
 - Move down
 - Move to bottom
 - Use FPK order
 - Add all lines
 - Save
 - Do not save

- BLF?

- Busy Lamp Field: **not** for OpenScope Voice
- Return?

Phone?

- Display?
 - Option: Save & Exit
 - Exit (Discard Changes)
 - Brightness  → page 162
 - Contrast:  → page 161
 - Key mod. contrast:  → page 164
- Program keys
 - Press the key to be programmed*

[1]. Information - read only

- Option: Save & Exit
 - Exit (Discard Changes) → page 71
- Normal: Unallocated
 - Unallocated → page 211
 - *Further functions, see* → page 211
- Label: *predefined or customized*
- Settings: *function-dependent*
- Shifted: Unallocated → page 71
 - Unallocated → page 212
 - *Further functions, see* → page 212
- Label: *predefined or customized*
- Settings: *function-dependent*
- Key Module (if available such as Program keys)
- Tastenklick
 - Option Save & Exit
 - Exit (Discard Changes)
 - Lautstärke → page 176
 - Off
 - Low
 - Mittel
 - High
 - Tasten → page 176
 - Nur Tastenfeld
 - Alle Tasten
- Energy saving mode → page 163
 - Time for background lighting
 - Background lighting: 1 minute
 - Background lighting: 5 minutes
 - Background lighting: 30 minutes
 - Background lighting: 60 minutes
 - Background lighting: 2 hours
 - Background lighting: 4 hours
 - Background lighting: 8 hours
- Return?

Locality?





- Option: Save & Exit
 - Exit (Discard Changes)
- Country: DE → page 179
 - DE? → page 179
 - *Further countries, see* → page 179
- Language: Deutsch → page 177
 - Deutsch → page 178
 - *Further languages, see* → page 178
- Date format: dd/mm/yyyy → page 168
 - dd/mm/yyyy
 - yyyy/mm/dd
 - mm/dd/yyyy

- Time format: 24 hour → page 168
 - 24 hour
 - 12 Hour (AM/PM)

Security?

- Option: Save & Exit
 - Exit (Discard Changes)
- User password: ***** → page 136
- Confirm password:

Network information?

- Option: Exit
- Phone address: → page 182
- Web address:
- IP address:
- LAN RX: 
- LAN TX: 
- PC RX: 
- PC TX: 
- LAN autonegotiated: Yes
- LAN information: 10 Mbps full duplex
- PC autonegotiated: Yes
- PC information: Link down

Reset?

- Option: Cancel
 - Cancel
 - Reset all user data → page 183
 - Reset selected user data → page 77
- Function key data: No? → page 77
 - Yes
 - No

Key functions

Normal

You can program the following functions on the Normal of the function keys:

- Selected dialling
- Repeat dialling
- Forward all calls
- Forward no reply
- Forward busy
- Mute
- Ringer off
- Hold
- Alternate
- Blind transfer call
- Transfer call
- Deflecting
- Shift
- Conference
- Headset
- Do not disturb
- Group pickup
- Repertory dial
- Feature toggle
- Mobility
- Directed pickup
- Callback
- Cancel callbacks
- Consultation
- Call Waiting toggle
- Immediate ring
- PreView
- Start application
- Built in fwd
- Opening the phonebook

Shifted

You can program the following functions on the Shifted of the function keys:

- Selected dialling
- Repeat dialling
- Alternate
- Blind transfer call
- Transfer call
- Deflecting
- Conference
- Repertory dial
- Release
- Callback
- Cancel callbacks
- Consultation
- Start application

Index

A

Accepting calls	
multi-line	112
Administration	38
Alternate	57
Audio	
room character	170
volume	169
Audio controls	19
Audio keys	19
Autodial delay	97
Auto-headset	42

B

Background lighting	163
Busy override	118

C

Call	
accepting	41
deflect	78
ending	47
forwarding	60
hold	82
incoming	40
rejecting	80
transfer	90
Call forwarding chain	65
Call forwarding information	114
Call lists	35, 108
Call log	35
Call recording	
alternating	191
automatic	187
AutoStart	188
call types	185
conference	192
consultation	189
controlling	189

line key	193
manual	188
modes	184
Multiline	186
second call	190
symbols	186
tips	186
using	187
Call settings	
CTI calls	170
MultiLine	128
Call signaling different	40
Call waiting	86
Callback	66
CE marking	2
Conference	100
conference	
starting conference	56
Connection options	15
Consultation	56
Consultation call from second call	86
Context	53
Context menus	27

D

Date	165
Dial plan	97, 138
Different call signaling	40
Display brightness	162
Display icons	26
Display settings	
contrast	161
Do not disturb	134
DSS call	
call deflection	121
DSS key	
consultation	119
indirect pickup	120
reject call	120
During calls	
multi-line	115

E

Emergency call	138
Emergency number	138
Energy saving mode	163
Executive/secretary	122

F

Forced logoff	144
Forwarding primary line	114
Function keys	19

G

General information	11
Graphic display	26
call lists	36
icon indicating call status	29
voicemail	34
Graphic display settings	
contrast	161
Group call	48

H

Headset	78
answering call automatically	42
Hot line	54
for lines	117

I

Icons	26
Immediate dialing	53, 97
Important information	3
Incoming calls	
multi-line	112

K

Key click	176
Key module contrast	164
Key modules	17
Keypad	24

L

Language setting	177
country setting	179
language for user prompts	177
LDAP	108
LED display	
direct station selection keys	21
function keys	21
Line preview	131
Line utilization	22
Lines	
hot/warm line	117
Lists (for phone numbers and contacts)	111
Location of the telephone	3
Logging on and off	
as a mobility user	141, 143

M

Making calls	
multi-line	113
Microphone	47
Mobility	140
forced logoff	144
logon, logoff	141, 143
Multi-line	
accepting calls	112
LED display	23, 121
Multiline	
busy override	118
Multi-line telephone	13

N

Navigator	20
Normal dialing	53

O

Open listening	46
OpenScope Voice	145
abbreviated dialing	
two-key abbreviated dialing	151
accepting anonymous calls	150
call tracing	151
creating a list for selective calls	148
feature toggle key	145
functions	145
hunt group	152
making anonymous calls	146
parallel call	155
parking	157
reachability	154
rejecting anonymous calls	150
serial call	154
silent monitoring	158
OpenStage Key Module 40	17
Operating instructions	2
Overview tab	124, 127

P

Padlock icon	40
Parallel call	155
Parking	157
Pattern melody	171
Pattern sequence	172
Phantom line	22
Phone number directories	111
Phone settings	161
Phonebook	32
LDAP	33, 108
local phonebook	32
new contact	105
Picking up the held call	44
Pop-up menu	29

Primary line	22
Privacy	133
Private line	22
Program/Service menu	37
Programmable sensor keys	21, 70

R

Reachability	154
Redial	55
Redialing	
multi-line	114
Repdial keys	95
Resetting sensor keys	77
Ringer off	133

S

Search contacts,	32
Second call	86
deflecting	87
ignoring	87
rejecting	87
Second call with consultation call	86
Secondary line	22
Security	133
Sensor keys	
immediate ring	76
Serial call	154
Set headset port	174
Settings	161
Shared line	22
Silent monitoring	158
Single-line telephone	13
Speakerphone distance	3
Speakerphone mode	41, 45
Status icons	26

T

Telephone maintenance	201
Telephony interface	
single line	29
Time	165
Time display format	168
Troubleshooting	201
Trunk keys	22

U

User interface 14
User support 12
Using Ethernet switches 16
Using network ports more efficiently 16

W

Warm line 54
 for lines 117
Web interface 195, 203

Communication for the open minded

Siemens Enterprise Communications
www.siemens-enterprise.com

Copyright © Siemens Enterprise
Communications GmbH & Co. KG
Hofmannstr. 51
80200 München
Deutschland

Siemens Enterprise
Communications GmbH & Co. KG
is a Trademark Licensee of Siemens AG

Reference No:
A31003-S2010-U101--33-7619

The information provided in this document contains merely general descriptions or characteristics of performance which in case of actual use do not always apply as described or which may change as a result of further development of the products.

An obligation to provide the respective characteristics shall only exist if expressly agreed in the terms of contract. Availability and technical specifications are subject to change without notice. OpenScape, OpenStage and HiPath are registered trademarks of Siemens Enterprise Communications GmbH & Co. KG. All other company, brand, product and service names are trademarks or registered trademarks of their respective holders.